



DLP® HIGH-DEFINITION TELEVISION MODELS

WD-57833

WD-65833

WD-73833

OWNER'S GUIDE

- For questions:
 - Visit our website at www.mitsubishi-tv.com.
 - E-mail us at MDEAservice@mdea.com.
 - Call Consumer Relations at 800-332-2119.
- For information on **System Reset**, please see the back cover.
- To order replacement or additional remote controls, lamp cartridges, or Owner's Guides, visit our website at www.mitsuparts.com or call 800-553-7278.
- Guidelines for setting up and using your new widescreen TV start on page 11.



x.v.Color

HDMI[™]
HIGH DEFINITION MULTIMEDIA INTERFACE



PICTURE BY
DLP[®]
TEXAS INSTRUMENTS

Simply **HD**[™]

For Your Records

Record the model number, serial number, and purchase date of your TV. The model and serial numbers are on the back of the TV. Refer to this page when requesting assistance with the TV.

MODEL NUMBER _____

SERIAL NUMBER _____

PURCHASE DATE _____

RETAILER NAME _____

LOCATION _____



CAUTION
RISK OF ELECTRIC SHOCK
DO NOT OPEN



CAUTION: TO REDUCE THE RISK OF ELECTRIC SHOCK, DO NOT REMOVE COVER (OR BACK). NO USER SERVICEABLE PARTS INSIDE. REFER SERVICING TO QUALIFIED SERVICE PERSONNEL.



The lightning flash with arrowhead symbol within an equilateral triangle is intended to alert the user of the presence of uninsulated “dangerous voltage” within the product’s enclosure that may be of sufficient magnitude to constitute a risk of electric shock to persons.



The exclamation point within an equilateral triangle is intended to alert the user to the presence of important operating and maintenance (servicing) instructions in the literature accompanying the product.

WARNING: TO REDUCE THE RISK OF FIRE OR ELECTRIC SHOCK, DO NOT EXPOSE THIS APPLIANCE TO RAIN OR MOISTURE.

TV WEIGHT: This TV is heavy! Exercise extreme care when lifting or moving it. Lift or move the TV with a minimum of two adults. To prevent damage to the TV, avoid jarring or moving it while it is turned on. Always power off your TV, unplug the power cord, and disconnect all cables before moving it.

WARNING: This product contains chemicals known to the State of California to cause cancer and/or birth defects or other reproductive harm.

FCC Declaration of Conformity

Product: Projection Television Receiver
Models: WD-57833, WD-65833, WD-73833
Responsible Party: Mitsubishi Digital Electronics America, Inc.
9351 Jeronimo Road
Irvine, CA 92618-1904
Telephone: (800) 332-2119

This device complies with Part 15 of the FCC Rules. Operation is subject to the following two conditions:
(1) This device may not cause harmful interference, and
(2) this device must accept any interference received, including interference that may cause undesired operation.

Note: This equipment has been tested and found to comply with the limits for a Class B digital device, pursuant to part 15 of the FCC Rules. These limits are designed to provide reasonable protection against harmful interference in a residential installation. This equipment generates, uses and can radiate radio frequency energy and, if not installed and used in accordance with the instructions, may cause harmful interference to radio communications. However, there is no guarantee that interference will not occur in a particular installation. If this equipment does cause harmful interference to radio or television reception, which can be determined by turning the equipment off and on, the user is encouraged to try to correct the interference by one or more of the following measures:

- Reorient or relocate the receiving antenna.
- Increase the separation between the equipment and the receiver.
- Connect the equipment into an outlet on a circuit different from that to which the receiver is connected.
- Consult the dealer or an experienced radio/TV technician for help.

Changes or modifications not expressly approved by Mitsubishi could cause harmful interference and would void the user’s authority to operate this equipment.

Contents

Important Information About Your TV

General Warnings and Cautions, Notes on Installation and Operation	4
Important Safeguards	5

1 Television Overview

Package Contents	6
Special Features of Your TV	6
TV Front Panel	7
TV Back Panel	9

2 TV Setup

Guidelines for Setting Up and Using Your New Widescreen TV	11
Installing the Remote Control Batteries	12
When You First Power On the TV	12
Initial TV Setup	12
Setting Up TV Inputs	13
Controlling A/V Receiver Sound Volume	14
Using the TV with a Personal Computer	15

3 TV Connections

Before you Begin	17
HDTV Cable Box or Satellite Receiver with Component Video	17
HDMI Device (Cable Box, Satellite Receiver, DVD Player, or Other Device)	18
Standard Cable Box, Satellite Receiver, or Other Device with S-Video	18
Wall Outlet Cable (no cable box)	19
Antenna with a Single Lead	19
Antennas with Separate UHF and VHF Leads	19
DVD Player with Component Video	20
DVI Video Device (Cable Box, Satellite Receiver, DVD Player, or Other Device)	20
VCR to an Antenna or Wall Outlet Cable	21
VCR to a Cable Box (Audio & Video)	22
A/V Receiver (Sound System)	23
Older Cable Box	23
Camcorder	24
IEEE 1394 Devices	25

4 TV Operation and Features

Choosing a Viewing Source	27
Sleep Timer	27
Remote Control	28
ChannelView Channel Listings	30
Status Display	31

Fav (Favorite Channels)	32
TV Signals and Display Formats	33
Split Screen	35
Viewing Camera Files	36
JPEG Photos and the USB Photo Port	36
Photos and Moving Video as Composite Video	37

5 TV Menu Settings

Main Menu	38
Remote Control Keys for the TV Menu System	38
AV Menu	39
Video Menu	41
Audio Menu	42
Captions Menu	43
Setup Menu	44
Inputs Menu	49
Lock Menu	51
Pass Codes	51
Parent Menu	51
Other Menu (Alternate Rating System)	51
Bypassing TV Locks	51

6 NetCommand

About NetCommand	54
IR Emitter Placement (NetCommand)	55
Initial NetCommand Setup for Most Devices	56
Add or Remove Device Keys from NetCommand Control	56
NetCommand Specialized Device Keys	57
Operating NetCommand-Controlled Devices	58
Setting Up NetCommand Control of an A/V Receiver	60
NetCommand-Controlled Recording	63
Using IEEE 1394 Devices	66

Appendices

Appendix A: Specifications	68
Appendix B: Lamp-Cartridge Replacement and Cleaning	69
Appendix C: Bypassing the Parental Lock	71
Appendix D: Programming the Remote Control	73
Appendix E: Troubleshooting	81

Trademark and License Information	89
--	----

Mitsubishi TV Software	90
---	----

Mitsubishi DLP Projection Television Limited Warranty	91
--	----

Index	93
------------------------	----

Important Information About Your TV

Installation Notes

Stand Requirement

Mitsubishi does not design, manufacture or sell matching bases for 833 series model televisions (WD-57833, WD-65833, WD-73833). When selecting a stand, base or other furniture to support the TV, please make sure it is designed with the appropriate dimensions for stability and to support the TV's total weight as well as the weight of any additional equipment you plan to store.

Custom cabinet installation must allow for proper air circulation around the television.

NOTE TO CATV SYSTEM INSTALLER: THIS REMINDER IS PROVIDED TO CALL THE CATV SYSTEM INSTALLER'S ATTENTION TO ARTICLE 820-40 OF THE NEC THAT PROVIDES GUIDELINES FOR THE PROPER GROUNDING AND, IN PARTICULAR, SPECIFIES THAT THE CABLE GROUND SHALL BE CONNECTED TO THE GROUNDING SYSTEM OF THE BUILDING, AS CLOSE TO THE POINT OF CABLE ENTRY AS PRACTICAL.

Operating Notes

Internal Fans

Internal cooling fans maintain proper operating temperatures inside the TV. It is normal to hear the fans when you first turn on the TV, during quiet scenes while viewing the TV, and for a short time after turning off the TV.

TV Guide On Screen Access Requirements

TV Guide On Screen® listings are not provided by Mitsubishi Digital Electronics America, Inc. Operation of TV Guide On Screen requires over-the-air or cable access to stations carrying TV Guide On Screen program listings. If listings are not available in your area or become discontinued by the local provider, TV Guide On Screen will not operate. TV Guide On Screen does not provide program listings for satellite TV systems.

Lamp Replacement

For lamp-replacement instructions, see Appendix B.

To Order a Replacement Lamp Under Warranty

Call (800) 553-7278. Please have model number, serial number, and TV purchase date available.

Important: All lamps replaced under warranty must be returned to Mitsubishi where they will be inspected for defect verification.

To Purchase a Replacement Lamp After Warranty

Visit our website at www.mitsuparts.com or call (800) 553-7278. Order new lamp part number 915P061010.

TV Software

Do not attempt to update the software of this TV with software or USB drives not provided by or authorized by Mitsubishi Digital Electronics America, Inc. Non-authorized software may damage the TV and will not be covered by the warranty.

Cleaning Recommendations

Normally, light dusting with a dry, non-scratching duster will keep your TV clean. If cleaning beyond this is needed, please use the following guidelines:

First, turn off the TV and unplug the power cord from the power outlet.

Occasionally clean dust build-up from the air-intake grilles on the back and sides of the TV. Clean using a vacuum cleaner with a brush attachment.

Glossy Surfaces

Use the soft cleaning cloth supplied with the TV.

- Clean the cloth before each use by shaking or brushing to remove any residual dirt particles.
- Gently wipe down the glossy surfaces of your TV with the soft cloth. Do not apply pressure while wiping.
- If necessary, lightly dampen the soft cloth with water. Do not use chemical or abrasive cleaners.
- Wash the soft cloth by hand or machine. Use only mild soap.

Top and Sides of the TV (non-glossy surfaces)

- Gently wipe down your TV with a soft, non-abrasive cloth such as cotton flannel or a clean cloth diaper, lightly moistened with water. Dry with a second dry, soft, non-abrasive cloth.
- For oily dirt, add a few drops of mild liquid detergent, such as dishwashing detergent, to the water used to moisten the cloth. Rinse with a second cloth moistened only with water. Dry with a third dry, soft, non-abrasive cloth.

Screen

- Follow the instructions for the top and sides, wiping gently in an up and down motion.
- Clean the entire screen evenly, not just sections of the screen.
- Do not allow liquid to drip down the screen, as some liquid may enter the TV through the gap between the screen and screen frame.
- You may purchase Mitsubishi Screen Cleaner, part number CLEANER-VSS, by calling (800) 553-7278.

General Cleaning Precautions

- DO NOT allow liquid to enter the TV through the ventilation slots or any crevice.
- DO NOT use any strong or abrasive cleaners, as these can scratch the surfaces.
- DO NOT use any cleaners containing ammonia, bleach, alcohol, benzene, or thinners, as these can dull the surfaces.
- DO NOT spray liquids or cleaners directly on the TV's surfaces.
- DO NOT scrub or rub the TV harshly. Wipe it gently.

Important Safeguards

Please read the following safeguards for your TV and retain for future reference. Always follow all warnings and instructions marked on the television.

- 1. Read, Retain and Follow All Instructions.** Read all safety and operating instructions before operating the TV. Retain the safety and operating instructions for future reference. Follow all operating and use instructions.
- 2. Heed Warnings.** Adhere to all warnings on the appliance and in the operating instructions.
- 3. Cleaning.** Unplug the TV from the wall outlet before cleaning. Do not use liquid, abrasive or aerosol cleaners. Cleaners can permanently damage the cabinet and screen. Use a lightly dampened cloth for cleaning.
- 4. Attachments and Equipment.** Never add any attachments and/or equipment without approval of the manufacturer as such additions may result in the risk of fire, electric shock or other personal injury.
- 5. Water and Moisture.** Do not use the TV where contact with or immersion in water is possible. Do not use near bath tubs, wash bowls, kitchen sinks, laundry tubs, in a wet basement, swimming pools, etc.
- 6. Accessories.** Do not place the TV on an unstable cart, stand, tripod, or table. The TV may fall, causing serious injury to a child, adult or pet and serious damage to the TV. Use only with a cart, stand, tripod, bracket or table recommended by the manufacturer, or sold with the TV. Any mounting of the TV should follow the manufacturer's instructions, and should use mounting accessories recommended by the manufacturer.
An appliance and cart combination should be moved with care. Quick stops, excessive force, and uneven surfaces may cause the appliance and cart combination to overturn.
- 7. Ventilation.** Slots and openings in the cabinet are provided for ventilation and to ensure reliable operation of the TV and to protect it from overheating. Do not block these openings or allow them to be obstructed by placing the TV on a bed, sofa, rug, or other similar surface. Nor should it be placed over a radiator or heat register. If the TV is to be placed in a rack or bookcase, ensure that there is adequate ventilation and that the manufacturer's instructions have been adhered to.
- 8. Power Source.** This TV should be operated only from the type of power source indicated on the marking label. If you are not sure of the type of power supplied to your home, consult your appliance dealer or local power company.
- 9. Grounding or Polarization.** This TV is equipped with a polarized alternating current line plug having one blade wider than the other. This plug will fit into the power outlet only one way. This is a safety feature. If you are unable to insert the plug fully into the outlet, try reversing the plug. If the plug should still fail to fit, contact your electrician to replace your obsolete outlet. Do not defeat the safety purpose of the polarized plug.
- 10. Power-Cord Protection.** Power-supply cords should be routed so that they are not likely to be walked on or pinched by items placed upon or against them, paying particular attention to cords at plugs, convenience receptacles, and the point where they exit from the TV.
- 11. Lightning.** For added protection for this TV during a lightning storm, or when it is left unattended and unused for long period of time, unplug it from the wall outlet and disconnect the antenna or cable system. This will prevent damage to the TV due to lightning and power-line surges.
- 12. Power Lines.** An outside antenna system should not be located in the vicinity of overhead power lines or other electric light or power circuits, or where it can fall into such power lines or circuits. When installing an outside antenna system, extreme care should be taken to keep from touching such power lines or circuits as contact with them might be fatal.
- 13. Overloading.** Do not overload wall outlets and extension cords as this can result in a risk of fire or electric shock.
- 14. Object and Liquid Entry.** Never push objects of any kind into this TV through openings as they may touch dangerous voltage points or short-out parts that could result in fire or electric shock. Never spill liquid of any kind on or into the TV.
- 15. Outdoor Antenna Grounding.** If an outside antenna or cable system is connected to the TV, be sure the antenna or cable system is grounded so as to provide some protection against voltage surges and built-up static charges.
Article 810 of the National Electric Code, ANSI/NFPA No. 70-2002, provides information with respect to proper grounding of the mast and supporting structure, grounding of the lead in wire to an antenna discharge unit, size of grounding conductors, location of antenna discharge unit, connection to grounding electrodes, and requirements for the grounding electrode.
- 16. Servicing.** Do not attempt to service this TV yourself as opening or removing covers may expose you to dangerous voltage or other hazards. Refer all servicing to qualified service personnel.
- 17. Damage Requiring Service.** Unplug the TV from the wall outlet and refer servicing to qualified service personnel under the following conditions:
 - When the power-supply cord or plug is damaged.
 - If liquid has been spilled, or objects have fallen into the TV.
 - If the TV has been exposed to rain or water.
 - If the TV does not operate normally by following the operating instructions, adjust only those controls that are covered by the operating instructions as an improper adjustment of other controls may result in damage and will often require extensive work by a qualified technician to restore the TV to its normal operation.
 - If the TV has been dropped or the cabinet has been damaged.
 - When the TV exhibits a distinct change in performance - this indicates a need for service.
- 18. Replacement Parts.** When replacement parts are required, be sure the service technician has used replacement parts specified by the manufacturer or have the same characteristics as the original part. Unauthorized substitutions may result in fire, electric shock or other hazards.
- 19. Safety Check.** Upon completion of any service or repair to the TV, ask the service technician to perform safety checks to determine that the TV is in safe operating condition.
- 20. Heat.** The product should be situated away from heat sources such as radiators, heat registers, stoves or other products (including amplifiers) that produce heat.

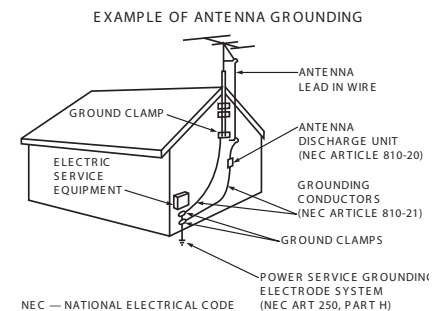

1 Television Overview

Package Contents

Please take a moment to review the following list of items to ensure that you have received everything.

1. **Remote Control**
2. **Two AA Batteries**
3. **Owner's Guide**
4. **Quick Reference Guide**
5. **Quick Connect Guide**
6. **Product Registration Card**
7. **Four-Ended IR Emitter**
8. **TV Guide On Screen[®] Interactive Program Guide User's Manual**
9. **Cleaning Cloth for Glossy Surfaces** (see instructions under "Cleaning Recommendations").

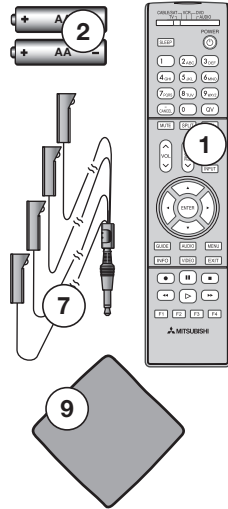

Special Features of Your TV

Your new high-definition widescreen television has many special features that make it the perfect center of your home entertainment system, including:

1080p High-Definition DLP Display System

Your Mitsubishi HDTV uses Texas Instruments Digital Light Processing™ technology for rear-projection TVs to create the picture you see on screen. All images are displayed at 1080p. The TV uses Plush 1080p[®] to convert lower-resolution signals to 1080p for display. The TV can also accept 1080p original signals and maintain them at 1080p through all processing until displayed.

16:9 Widescreen Picture Format

Enjoy a full theatrical experience in the comfort of your home. View pictures as film directors intended them. Digital TV broadcasts, DVDs and newer video game consoles support this widescreen format.

Integrated HDTV Tuner

Your widescreen Mitsubishi HDTV has an internal HDTV tuner able to receive both over-the-air HDTV broadcasts (received via an antenna) and non-scrambled digital cable broadcasts, including non-scrambled HDTV cable programming.

High-Definition Video Inputs

- ◆ **Component Video Inputs.** Also called Y/Pb/Pr inputs, these inputs receive standard analog video formats of 480i, 480p, 720p, and 1080i high-definition signals. This provides a high level of flexibility when connecting DVD players/recorders, cable boxes, and satellite receivers.
- ◆ **HDMI 1.3 Inputs.** These inputs accept digital 480i, 480p, 720p, 1080i, and 1080p video signals plus PCM digital stereo signals. The HDMI™ inputs can also accept a variety of PC signals and resolutions. These inputs are compatible with Deep Color and **x.v.Color**.
Used with an adapter, these inputs also accept compatible digital DVI video signals. HDMI inputs provide additional high-performance, high-definition connections for maximum flexibility in your choice of home theater products. The HDMI inputs are HDCP copy-protection compatible.
- ◆ **IEEE 1394 Digital Interfaces** that receive and send compressed digital signals, including high-definition signals, along with digital audio and control signals between devices such as the TV, a digital cable box, an A/V disc, and a D-VHS digital video recorder.

Easy Connect Auto Input Sensing

Easy Connect™ Auto Input Sensing automatically recognizes when you plug in an input and prompts you to assign a name to it. The TV ignores any unused inputs, so the result is an uncluttered **Input Selection** menu where you can easily find and select connected devices by name.

Home Theater Control

NetCommand with IR Learning

Your Mitsubishi HDTV offers a new level of networking that seamlessly integrates selected older A/V products with new and future digital products. NetCommand[®] supports IR (infrared) control of products such as VCRs, DVD players, cable boxes, and satellite receivers. NetCommand can "learn" remote control signals directly from many devices, allowing you to create a customized NetCommand-controlled home-theater system.

NetCommand for HDMI Devices

Some newer HDMI devices may be compatible with the TV's NetCommand for HDMI feature. Compatible devices can receive control signals through the HDMI connection. The TV's remote control may be able to operate some functions of these devices without any further setup.

TV Front Panel

Control Panel

Buttons on the front control panel duplicate commonly used keys on the remote control. The upper labels show control functions when no TV menus are displayed; the lower labels indicate functions when TV menus are displayed or when a special function has been activated. See chapter 4, "TV Operation and Features," for the functions of these buttons.

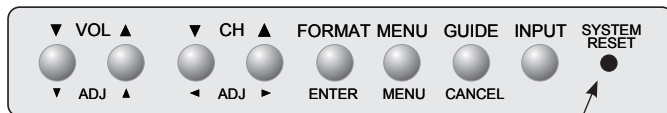
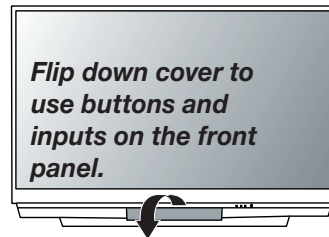

Front Control Panel. Buttons on the front panel duplicate some keys on the remote control.

System Reset Button

If the TV fails to respond to the remote control, front panel controls, or will not power on/off, press the **SYSTEM RESET** button on the front panel.

The green LED on the front panel will flash quickly for about one minute. When the green LED stops flashing, you may turn on the TV. Recent setting changes you made before using **SYSTEM RESET** may be lost.

**SYSTEM
RESET**

A/V Reset

If you wish to reset the A/V (Audio/Video) settings back to the factory defaults:

- To reset all settings at once, press **GUIDE** and **FORMAT** on the front panel at the same time.
- To reset the defaults for individual inputs, use the **Reset** selection on the **AV** menu.

TV Guide On Screen® Interactive Program Guide System

An eight-day on-screen program guide for cable and over-the-air reception. This subscription-free guide system lists regular, digital, and high-definition programming. Note that when the system is first set up, it may take up to 24 hours to begin to receive TV program listings and then it may take up to one week to receive all eight days of TV program listings.

Front Inputs

- INPUT/COMPONENT 3** is an easily accessible set of input jacks for a camcorder, game, or other audio/video device.
- A USB photo port lets you view JPEG images.
- A convenient fourth HDMI input is provided. If connecting a DVI device to the front HDMI jack, connect analog audio cables to the **INPUT 3 L** and **R AUDIO** jacks.

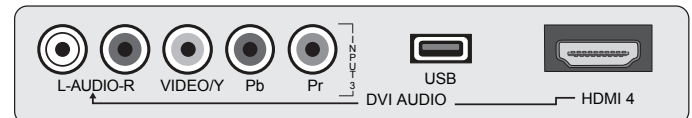

*Front inputs. When using a standard video device, connect the single (yellow) video cable to the **VIDEO/Y** jack.*

Front Panel Indicators and Power Button

- POWER** button. Turns TV on and off; works the same as the **POWER** key on the remote control.
- POWER/TIMER** indicator. Lit when TV is powered on; flashes when TV is powered off and the auto-on TV Timer is set; blinks rapidly when TV is first plugged into an AC outlet.
- STATUS** indicator. Off during normal TV operation.
- LAMP** indicator shows lamp condition (usually off during normal TV operation).

See the next page for more on front-panel indicators.

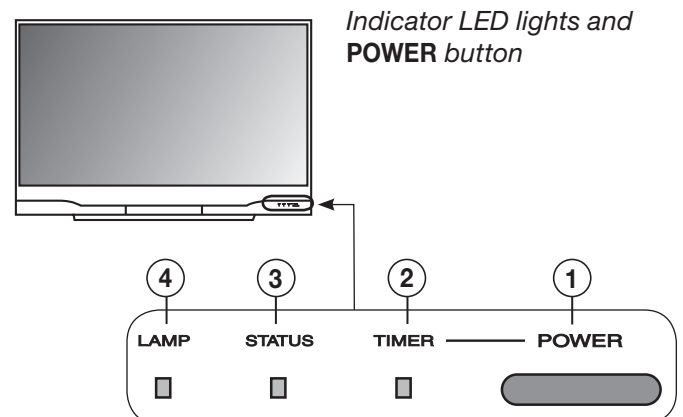

Front-Panel Indicators

○ Off ● Steady On ● Slow Blinking ● Fast Blinking

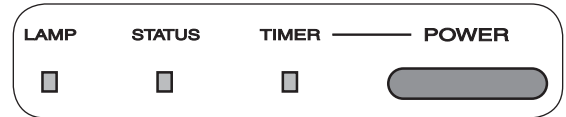

POWER/TIMER Indicator

LED Color	TV Condition	Additional Information
None ○	TV is powered off.	Normal operation.
Green ●	TV is powered on.	Normal operation.
Green ●	TV powered off, auto-on timer is set.	Normal operation. TV can be turned on at any time.
Green ●	<ol style="list-style-type: none"> TV just plugged into AC outlet. AC just restored after power failure. TV rebooting after System Reset used. TV rebooting after power fluctuation or receiving abnormal digital signals from a digital channel or digital device. You have begun the procedure to update software from an authorized flash memory device. 	Wait approximately one minute for blinking to stop before turning on. Normal operation.

STATUS Indicator

LED Color	TV Condition	Additional Information
None ○	Normal TV on or standby condition.	Normal operation.
Yellow ●	TV is too hot.	<p>The TV will display a warning message and shut off if it overheats.</p> <ul style="list-style-type: none"> Ambient room temperature may be too high. Turn off the TV and wait until the room temperature drops. Clear blocked air vents. Ensure at least a four-inch clearance on all sides of the TV. Clean the lamp-cartridge air filter. See Appendix B.
Red ●	TV may require service.	<p>Turn off the TV and unplug the set from the AC power source. Wait one minute and then plug the set back in. See Appendix E.</p> <p>If the LED is still on, contact your dealer or a Mitsubishi Authorized Service Center. Go to www.mitsubishi-tv.com or call 1-800-332-2119 to receive Authorized Service Center information.</p>

LAMP Indicator

LED Color	TV Condition	Additional Information
None ○	Normal TV on or standby condition.	Normal operation.
Green ●	TV just powered off and lamp is cooling.	Starts to blink 30 seconds after turning off TV. TV can be turned back on before blinking starts or after blinking stops, but not while the indicator is blinking. Normal operation.
Yellow ●	<ol style="list-style-type: none"> Lamp access door is open or not secure. No lamp installed. 	<p>TV will not operate until lamp access door is secure. See Appendix B for installation information.</p> <p>TV will not operate without a lamp. See Appendix B for installation information.</p>
Red ●	Lamp no longer illuminates and has reached the end of the lamp life.	Replace the lamp. The TV will not operate when the lamp no longer illuminates. See Appendix B for installation information.

TV Back Panel

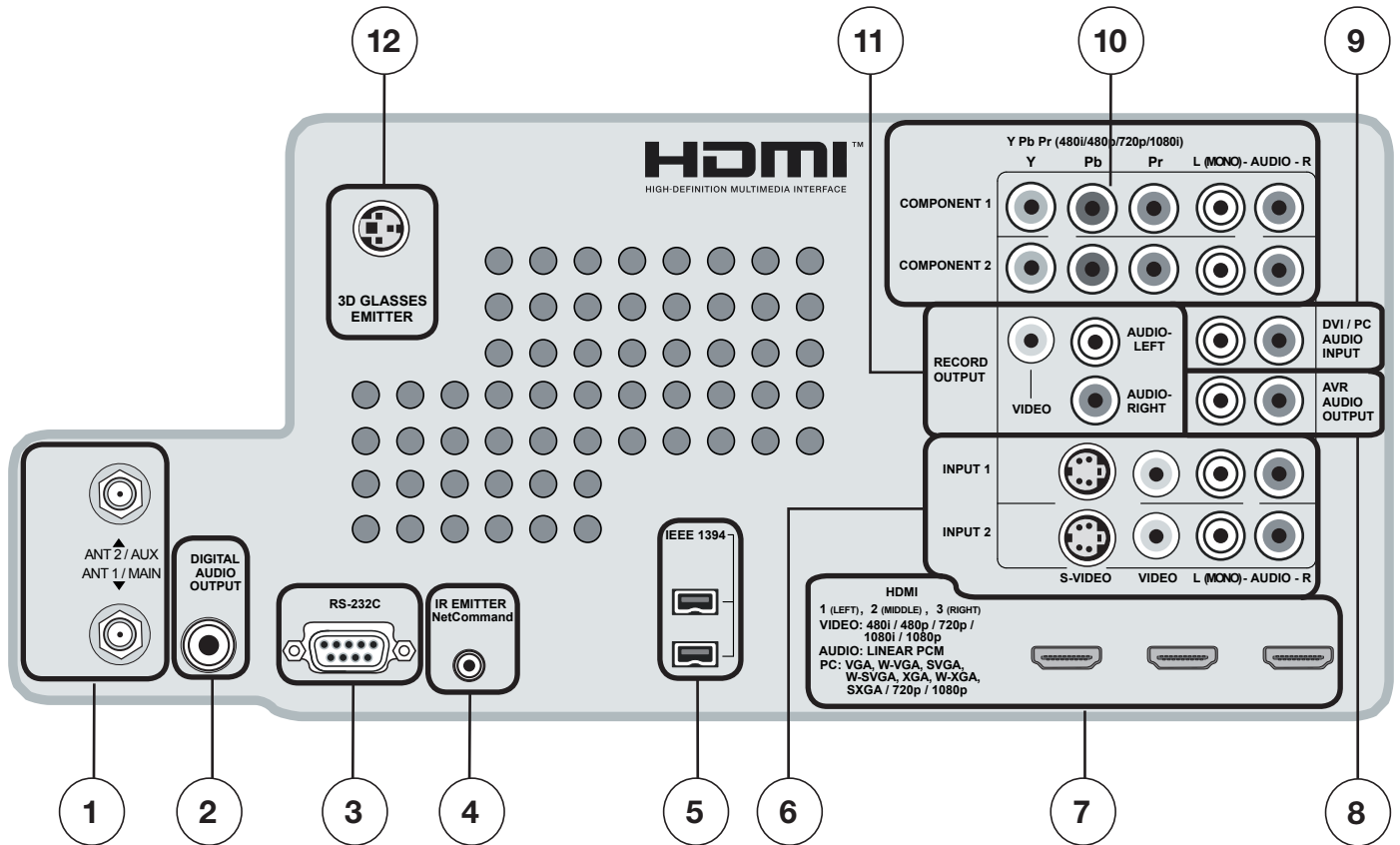

1. ANT 1/MAIN, ANT 2/AUX (Antenna)

If you are connecting an antenna or direct cable without a cable box, connect the main antenna or cable source to **ANT 1/MAIN**. Use **ANT 2/AUX** for a second source.

ANT 1/MAIN and **ANT 2/AUX** can each receive digital and analog over-the-air channels from a VHF/UHF antenna or non-scrambled digital/analog cable source.

2. DIGITAL AUDIO OUTPUT

This output sends Dolby Digital or PCM digital audio to your digital A/V surround sound receiver. Analog audio from analog channels and devices is converted by the TV to PCM digital audio. If you have a digital A/V receiver, in most cases this is the only audio connection needed between the TV and your A/V receiver.

3. RS-232C

Use the RS-232C interface to receive control signals from compatible home-theater control devices.

4. IR Emitter NetCommand

IR Emitters connected to this jack are used by the TV's NetCommand system to control external IR remote controlled analog devices such as cable boxes, VCRs, DVDs, satellite receivers and audio receivers.

5. IEEE 1394 (also known as Firewire®)

These jacks allow the TV to connect to external IEEE 1394 digital products by means of a single cable. See chapter 6, "NetCommand" for information regarding IEEE 1394 connections and recording.

6. INPUT (audio and video; front and rear)

INPUT jacks can be used to connect a VCR, Super VHS (S-VHS) VCR, DVD player, standard satellite receiver, or other A/V device to the TV. The **INPUT** groups on the back of the TV consist of jacks for composite video, S-Video, and analog stereo audio. Note that when you connect to the S-video jack, the composite video jack is automatically disabled. **INPUT 3** is a third set of composite video and stereo audio jacks located on the front of the TV for convenience.

TV Back Panel, continued

7. HDMI™ Inputs

The HDMI 1.3 (High Definition Multimedia Interface) supports uncompressed standard and high-definition digital video formats and PCM digital stereo audio format.

Use the HDMI inputs to connect to CEA-861 HDMI compliant devices such as a high-definition receiver or DVD player. These inputs support 480i, 480p, 720p, 1080i, and 1080p video formats.

Mitsubishi recommends you use category 2 HDMI cables to connect HDMI 1.3 source devices. High-speed category 2 cables bring you the full benefits of Deep Color and **x.v.Color**.

These inputs can also accept digital DVI video inputs. To connect a DVI input, use an HDMI-to-DVI adapter or cable plus analog audio cables. Connect the analog audio cables to the **DVI/PC AUDIO INPUT** on the TV to receive left and right stereo audio from your DVI device.

The TV's HDMI inputs are compatible with many DVI-D and HDMI computer video signals. See chapter 2, "TV Setup" and Appendix A for additional information on PC compatibility.

These inputs are HDCP (High-Bandwidth Digital Copy Protection) compliant.

These inputs are  certified for proper interoperability with other products certified by Simplay™.

HDMI Cable Categories

HDMI cables are available as Category 1 and Category 2 versions.

- **Category 2 Cables.** Newer, HDMI 1.3-compliant DVD players, video games, and set-top boxes require Category 2 cables. Use category 2 cables for these high-speed HD signals carrying extended color encodings (i.e., 30 or more bits, also called Deep Color). Category 2 cables are also suitable for standard HDTV signals.
- **Category 1 Cables.** Unmarked cables are category 1 cables and are suitable for standard HDTV signals.

8. AVR AUDIO OUTPUT

Use **AVR AUDIO OUTPUT** to send analog audio of the program currently shown on the screen to an A/V surround sound receiver or stereo system. Digital audio from digital channels and HDMI devices is converted to analog audio by the TV. If using an analog A/V receiver or stereo system, this is the only audio connection needed between it and the TV.

9. DVI/PC AUDIO INPUT

Use the **DVI/PC AUDIO INPUT** when connecting a DVI device to one of the TV's HDMI inputs using a DVI-to-HDMI cable. These jacks allow you to send left and right analog audio from your computer or other DVI device to the TV.

10. COMPONENT (audio and video; front and rear)

Y Pb Pr (480i/480p/720p/1080i)

Use these jacks to connect devices with component video outputs, such as DVD players, external HDTV receivers, or compatible video game systems. A third set of component jacks is located on the front of the TV and shares the left/right audio jacks and **VIDEO/Y** jack with the **INPUT 3** composite input. See Appendix A specifications for signal compatibility.

11. RECORD OUTPUT

Use these composite video and left/right audio jacks to send analog video and audio signals to an external recording device such as a VCR. **To make recordings from this output, the TV must be in normal full-screen mode rather than in Split Screen mode.**

- You can watch another device while recording, but not another channel.
- From this output you can record audio and video signals from **ANT 1**, **ANT 2**, **INPUT 1-3**, and IEEE 1394 devices.
- Digital signals from **ANT 1**, **ANT 2**, and IEEE 1394 devices are converted to analog video and audio signals.
- Some signals cannot be recorded because of copy-protection flags in the content.

12. 3D GLASSES EMITTER

The **3D GLASSES EMITTER** jack is in place for future gaming devices equipped with FX gaming 3D and dual-view features. Use this jack to connect a special IR emitter (supplied with the 3D glasses) that will synchronize your 3D glasses with the screen display.

2 TV Set-Up

Guidelines for Setting Up and Using Your New Widescreen TV

Getting Started

1. Review the important safety, installation, and operating information at the beginning of this book.
2. Choose a location for your TV.
 - Allow at least four inches of space on all sides of the TV to help prevent overheating. Overheating may cause premature failure of the TV as well as shortened lamp life.
 - Avoid locations where light may reflect off the screen.
 - See the stand requirements under “Important Information About Your TV.”
3. Install the batteries in the remote control. See the following page. See chapter 4, “TV Operation and Features” for more on use of the remote control.
4. Plug your TV into a power outlet. The green LED on the front of the TV will start blinking rapidly. After the green LED stops blinking, press the **POWER** key to power on the TV.
5. When the **Welcome** screen appears the first time you power on the TV, select a language for TV menus. You can later change the language through the **Setup** menu.
6. Connect your audio/video (A/V) devices to the TV and perform initial setup.
 - See chapter 3, “TV Connections” for connection diagrams.
 - See the following pages for initial TV setup and use of the Auto Input Sensing feature.
 - See chapter 6, “NetCommand,” to perform NetCommand IR “learning” for control of your home theater.
7. Mitsubishi recommends you perform a channel scan for channels received on **ANT 1** and **ANT 2**. See “Initial TV Setup” on the following pages.
8. You can now start watching TV or you can perform additional setup and customization through the TV menus.

TV Operation

1. Review chapter 4, “TV Operation and Features,” for TV features including:
 - **Input Selection (viewing source)**. Select a connected program source to watch, such as a VCR, DVD player, or antenna. Press **INPUT** on the remote control to select from icons for the TV inputs. See “Choosing a Viewing Source.”
 - **ChannelView™/TV Guide On Screen®**. Press **GUIDE** to see channel listings for programs on **ANT 1** and **ANT 2**. To override ChannelView and use the TV Guide On Screen system, see Chapter 5, “TV Menu Settings” and the **Inputs** menu **Guide** options.
 - **Picture Formats**. Press **FORMAT** to cycle through picture sizes and shapes to find the one best suited to the current program. See “TV Signals and Display Formats.”
2. To understand use of the **Input Selection** menu with NetCommand-controlled devices, see “Using NetCommand.”
3. To view JPEG photo files on the TV, see “Viewing Camera Files.”

Additional TV Setup

1. Review chapter 5, “TV Menu Settings,” to customize TV operation. Press the **MENU** key to enter the menu system. Some examples of settings you may wish to change include:
 - **Fav.** Use an on-screen menu to create custom lists of your favorite channels from **ANT 1** and **ANT 2**. See **Setup > Edit**.
 - **Order.** Rearrange the device icons in the **Input Selection** menu to put frequently used icons near the front. See **Inputs > Order**.
 - **Name.** Change the device names that appear in the **Input Selection** menu. See the **Inputs** menu **Name** options.
 - **TV Guide On Screen.** Set up and enable the TV Guide On Screen system. See the **Inputs > Guide** menu.

- **Parental Locks.** Restrict TV viewing by program rating, by channel, or by time of day. You can also disable the front-panel buttons if you have small children. See the **Lock > Parent** menu, the **Lock > Front Panel** menu, and **Setup > Edit > Lock**.
- **Video Settings.** Change video adjustments to get the best picture for your viewing conditions. See “AV Menu.”

Note: You may wish to change the Picture Mode from the default **Brilliant** to either **Bright** or **Natural**, which are suitable for most home viewing.

2. To program the remote control to operate A/V devices not under NetCommand control, see Appendix D, “Programming the Remote Control.”

TV Care

- **Lamp Cartridge.** When the lamp cartridge needs replacement, **replace the lamp yourself and save the cost of a service call.** See Appendix B for instructions.
- **General Cleaning.** See the cleaning recommendations under “Important Information About Your TV.”

Assistance

- For troubleshooting, service, and product support, see Appendix E.
- For warranty information, see the TV warranty in the back of this book.

Installing the Remote Control Batteries

1. Remove the remote control’s back cover by gently pressing in the tab and lifting off the cover.
2. Load the batteries, making sure the polarities (+) and (-) are correct. For best results, insert the negative (-) end first.
3. Snap the cover back in place.

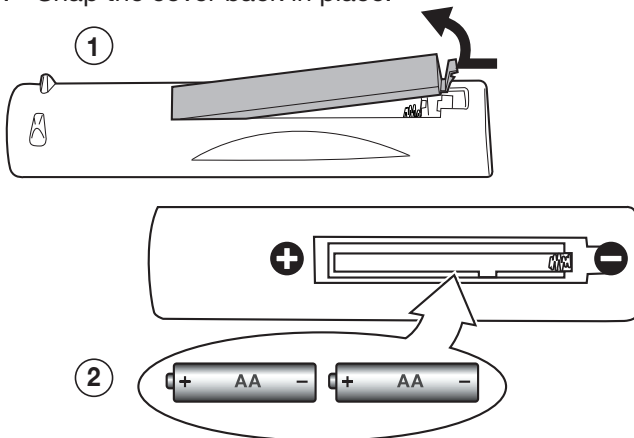

The remote control requires two AA alkaline batteries.

When You First Power On the TV

Choosing a Language for Menus

1. Power on the TV for the first time.
2. Press **▲▼** to select either **English** or **Spanish** for all menus. You can later change the language selection through the **Setup** menu Language option.

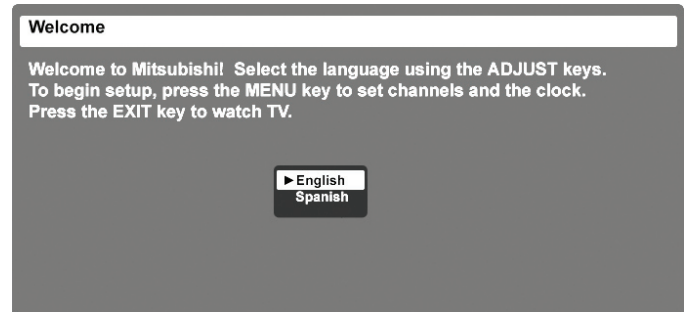

When you first power on the TV, the Welcome screen lets you change the menu language.

Initial TV Setup

Use the **Setup** menu for basic TV setup options.

1. Press **MENU** to open the **Main** menu.
2. Press **▼** to highlight the **Setup** icon and display the **Setup** menu.



Setup menu highlighted in TV Main menu

Turning the TV On or Off

To turn the TV on or off, point the remote control at the front of the TV and press the **POWER** button. Alternatively, press the **POWER** button on the front panel of the TV.

If You Turn Off the TV by Mistake

1. Press **POWER** again within about 30 seconds, while the lamp is still hot, to have the TV come back on immediately.
2. If the **LAMP** indicator starts blinking (about 30 seconds after you shut off power), **wait about one minute for the LAMP indicator to stop blinking and press POWER to turn the TV on again.**

Initial TV Setup, continued

Change the Menu Language

Choose to display on-screen menus in either English or Spanish (Español).



Select a menu language in the Setup menu.

1. With the **Setup** menu displayed, press **▶** to highlight the Language icon.
2. Press **▲▼** to highlight either **English** or **Spanish**.
3. Press **MENU** to return the highlight to the top row of icons.

Memorize Channels

For **ANT 1/MAIN** and **ANT 2/AUX**

To start channel memorization

1. With the **Setup** menu displayed, press **▶** to highlight the Scan icon.
2. Press **▲▼** to highlight an input selection based on your connections:

Input	Condition
Ant 1 Air Ant 2 Air	When connected to an indoor or outdoor antenna
Ant 1 Cable Ant 2 Cable	When connected to direct cable (no cable box)

3. Press **▶** to highlight the on-screen **START** button.
4. Press **ENTER** to start automatic channel memorization.

To stop channel memorization before completion, press CANCEL.

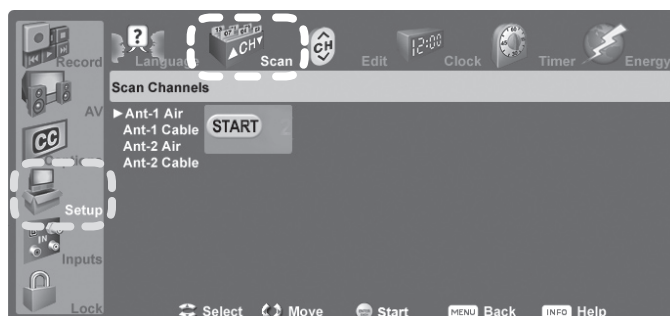

Start channel memorization from the Setup menu.

5. When memorization is complete you can:
 - Press **MENU** once to return to the top row of icons.
 - Press **MENU** again to return to the **Main** menu.
 - Press **EXIT** to watch TV.

After channels have been memorized:

- To tune to memorized channels, press **CH ▲/▼** while watching TV on the **ANT 1** or **ANT 2** inputs.
- Use the **Setup > Edit** menu for additional channel options, such as adding or deleting channels from memory, naming channels, and saving favorite channels in custom memory banks.

Additional TV Setup Using the Setup Menu

See chapter 5, “TV Menu Settings,” to:

- Edit channel options
- Set the TV clock
- Set the TV Timer
- Select an Energy Mode to manage power use while the TV is off.
- Select a lamp brightness mode

Setting Up TV Inputs

When You First Connect a Device

This TV's Easy Connect™ Auto Input Sensing feature detects most connections automatically. When you first connect a device, the TV will:

- a. detect the connected device
- b. prompt you to identify the device type
- c. prompt you to perform NetCommand set-up for the device, if available
- d. repeat these steps for any additional newly detected devices

The tables below state which connections trigger Auto Input Sensing.

Auto Detection Active	No Auto Detection
INPUT video jacks	ANT 1 and ANT 2
COMPONENT video jacks	
HDMI *	
DIGITAL AUDIO OUT	
AVR AUDIO OUTPUT (analog)	
USB (USB photo port on front)	

* If the device is powered off when connected, detection occurs when the device is next powered on.

Note: For connection and setup of a personal computer, see the information later in this chapter.

Setting Up TV Inputs, continued

- See chapter 3, “TV Connections,” for recommendations on connecting your devices.
- Connect your devices to the TV, making note of which TV input is used for each device.

The TV and the devices can be either on or off when connecting.

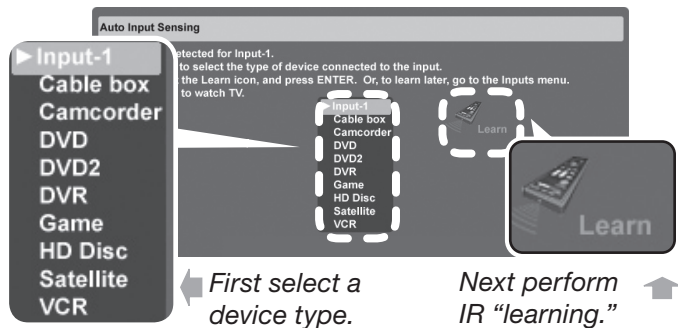

Auto Input Sensing screen for most device types.

- Power on the TV if not already on. When the TV detects a connection, the **Auto Input Sensing** screen opens.
 - Most Device Types:** Specify the device type and then, if desired, proceed directly to NetCommand setup.
 - In the **Auto Input Sensing** screen, press ▲ ▼ to move through the device list to select the device type connected to the input. The device type you select here will appear in the **Input Selection** menu.
 - You can perform NetCommand IR “learning” now or at a later time. To perform now, highlight the Learn icon and press ENTER. See chapter 6, “NetCommand” for more.
 - A/V Receiver:** The TV can detect audio connections on the **DIGITAL AUDIO OUT** jack and the right (red) analog **AVR AUDIO OUTPUT** jack.

Note for Analog A/V Receivers: When you disconnect an analog A/V receiver, be sure to change the **Speakers** setting manually to **TV** to hear sound from the TV speakers.

You can perform “learning” for the A/V receiver now or at a later time. To perform now, highlight the Learn icon in the **Auto Output Sensing** screen and press ENTER. See chapter 6, “NetCommand” for more.
 - HDMI Devices Compatible with the TV’s NetCommand for HDMI Feature:** Compatible HDMI devices are often recognized automatically by the TV. The TV’s remote control may operate some device functions without further setup. You can add more control functions if desired. Program the TV’s remote control or

perform NetCommand IR “learning” to add functions.

- Press EXIT to close the **Auto Input Sensing** screen. The TV will then display the **Auto Input Sensing** screen for the next connection it finds.

More About Auto Input Sensing

- Choose a different name for each input.
- Antenna inputs (**ANT 1/ANT 2**) are never detected, although you can turn off unused antenna inputs in the **Inputs > Name** menu.
- You can change the device type at a later time using the **Inputs > Name** menu. Any “learned” NetCommand IR codes will be erased, however.
- If you wish to change devices on an HDMI input:
 - Disconnect the HDMI device.
 - Turn off the HDMI input in the **Inputs > Name** menu.
 - Connect the new device and the **Auto Input Sensing** screen will display. If you want the device under NetCommand IR control, perform NetCommand “learning” for the new device.

Controlling A/V Receiver Sound Volume

Although the TV detects when you connect an A/V receiver, you must use one of the methods below to control sound volume from the A/V receiver.

With a Standard TV Setup

- Recommended Method:** Program the TV’s remote control for your A/V receiver and enable the Audio Lock feature. See Appendix D, “Programming the Remote Control.”
- Program the TV’s remote control for your A/V receiver and set the TV remote’s slide switch to the **AUDIO** position to control volume. Set the switch back to the **TV** position to control the TV.
- Use the remote control that came with the A/V receiver.

With NetCommand Control of an A/V Receiver

- Set up NetCommand control of the A/V receiver’s volume functions in the **Inputs > AVR** menu. The TV’s remote will then automatically control A/V receiver volume. See chapter 6, “NetCommand.”
- Use any of the methods described for the standard TV setup.

Using the TV with a Personal Computer

Connecting a Computer to the TV

Use one of the connection methods listed below based on your computer's video output.

Computer Video Output	Video Connection	Audio Connection
Digital DVI	DVI-to-HDMI cable or an HDMI cable with an HDMI-to-DVI adapter	Stereo audio cables
	Note: If the computer's audio output is a single mini jack, a mini audio-to-RCA-male "Y" adapter cable is also required.	
HDMI	HDMI-to-HDMI cable	No additional audio connection is required.

IMPORTANT

This TV accepts digital computer signals only.

1. See the TV specifications in Appendix A to confirm that your computer signal is compatible with the TV.
2. Connect the computer's digital signal output to one of the TV's **HDMI** jacks. See the connection diagrams for the method suited to your equipment.
3. Connect the computer's audio output using one of these options:
 - For digital DVI signals, connect analog left/right audio to the TV's **DVI/PC AUDIO INPUT** jack.
 - For HDMI signals, no additional audio connection is required.
4. Power on the TV and computer. The TV will detect the connection and display the **Auto Input Sensing** screen.
5. In the **Auto Input Sensing** screen, press **▲▼** to highlight **PC** in the list of device types. You can change the type at a later time using the **Inputs > Name** menu.
6. Press **EXIT** to close the **Auto Input Sensing** screen.

Note: If your computer provides digital audio output (coaxial or digital), you can connect it directly to a digital A/V receiver and bypass the TV.

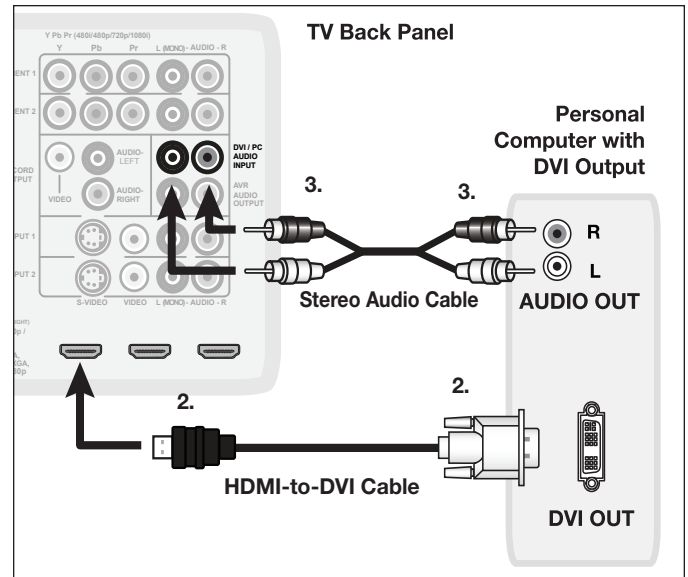

A DVI connection from a personal computer requires a separate audio connection. Computer connected to the TV back panel (above) and TV front panel (below).

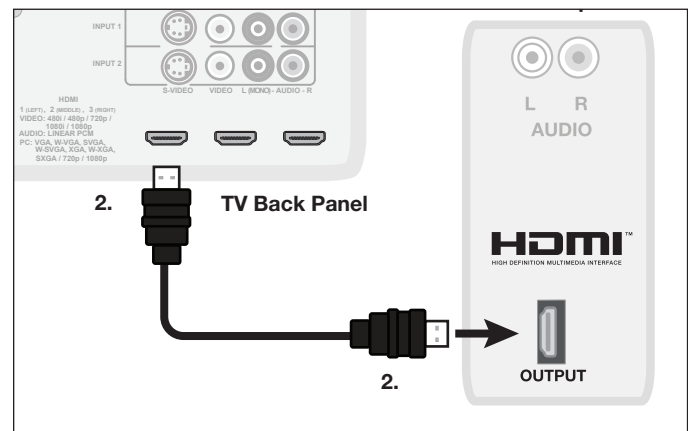
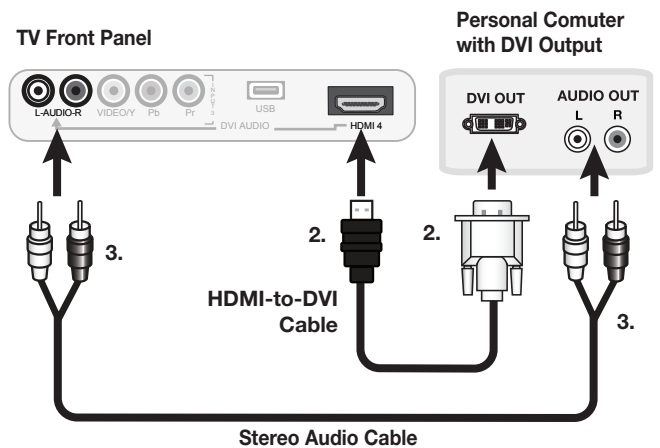

An HDMI-to-HDMI connection carries all video and audio on a single cable.

Using the TV with a Personal Computer

Computer Video Adjustments

1. Power on the computer if it is not already on.
2. Select **PC** from the **Input Selection** menu. To do this, press **INPUT** to open the **Input Selection** menu, move the highlight to the PC icon, and press **ENTER**.
3. Working from the computer, change the resolution of the computer image. View the computer image on the TV and maximize the computer resolution while maintaining a suitable aspect ratio for the image.
4. Perform TV video adjustments. Press **VIDEO** repeatedly to access video-adjustment options. The following additional adjustments are available for computer video:

Horiz Position (Horizontal Position). Manually adjust the horizontal position.

Vert Position (Vertical Position). Manually adjust the vertical position.

5. Press **FORMAT** repeatedly to find the picture format best suited to the image. See the chart on this page showing how different computer resolutions are displayed on the TV.

Distortion in Computer Images

Computer images may show distortion when viewed on the TV, e.g., lines that should be straight may appear slightly curved.

Image Resolution

Your Mitsubishi TV can display resolutions from standard VGA (640 x 480) through 1920 x 1080 signals at a refresh rate of 60 Hz. The resolution of 1920 x 1080 is supported at refresh rates of 24, 30, and 60 Hz. See Appendix A in this book for more on compatible screen resolutions.

In most cases, the computer will select the best resolution match to display on the TV. You can override this setting if you wish. Refer to your computer operating system's instructions for information on changing the screen resolution.













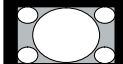



You may need to restart the computer for changes to take effect.









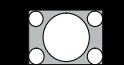

Tip:

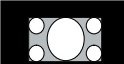

Set the computer's screen saver to display a pattern after several minutes of inactivity. This acts as a reminder that the TV is powered on and the lamp is in use. The lamp is in use whenever the TV is powered on, even if the screen appears dark.

Computer Display Formats

Press the **FORMAT** key repeatedly to cycle through the TV displays available for your computer's video signal.

Computer Signal		As Displayed on TV Screen		
Original Format		4 X 3 Standard	16 X 9 Standard	Zoom
VGA 640 X 480				
WVGA 848 X 480				
SVGA 800 X 600				
WSVGA 1064 X 600				

Original Format		Standard	Zoom
XGA 1024 X 768			
PC 720p 1280 X 720			
WXGA 1360 X 768			
SXGA 1280 X 1024			

Original Format		Standard	Reduce
PC 1080p 1920 X 1080			

3 TV Connections

Before you Begin

Auto Input Sensing

The TV's Auto Input Sensing feature automatically recognizes most connections and prompts you to identify the type of device connected. See chapter 2, "TV Setup," for more on Auto Input Sensing.

Connection Types

Review the connection types available on your input devices and use connections that will give the best video quality. For example, choose HDMI over component video, and choose component video over S-video or composite video.

Picture Quality

For best picture quality, route signals directly from the input device to the TV; avoid routing video signals through an A/V receiver, for example.

Sound Quality

For best surround sound audio quality, route audio signals from the input device directly to your A/V receiver or sound system whenever possible.

IMPORTANT

Accessory items such as cables, adapters, splitters, or combiners required for TV connections are not supplied with the TV. These items are available at many electronics stores.

HDTV Cable Box or Satellite Receiver with Component Video

If your cable box or satellite receiver has an HDMI output, use the connections for HDMI devices described later in this chapter.

Required: RCA component video cables, left/right analog stereo audio cables.

1. Connect the cable from the outside cable or satellite service to **CABLE IN** or **SATELLITE IN** on the cable box or satellite receiver. See your device's owner's guide for instructions and cable compatibility.
2. Connect RCA-type cables from the **Y Pb Pr** outputs on the HDTV cable box or satellite receiver to **COMPONENT** on the TV back panel, matching the colored green, blue, and red connections.
3. Connect left (white) and right (red) audio cables from the HDTV cable box or satellite receiver to **COMPONENT AUDIO L (MONO)** and **R** on the TV back panel.

Note: To hear digital surround sound, connect the digital audio output from your cable box or satellite receiver directly to your digital A/V receiver.

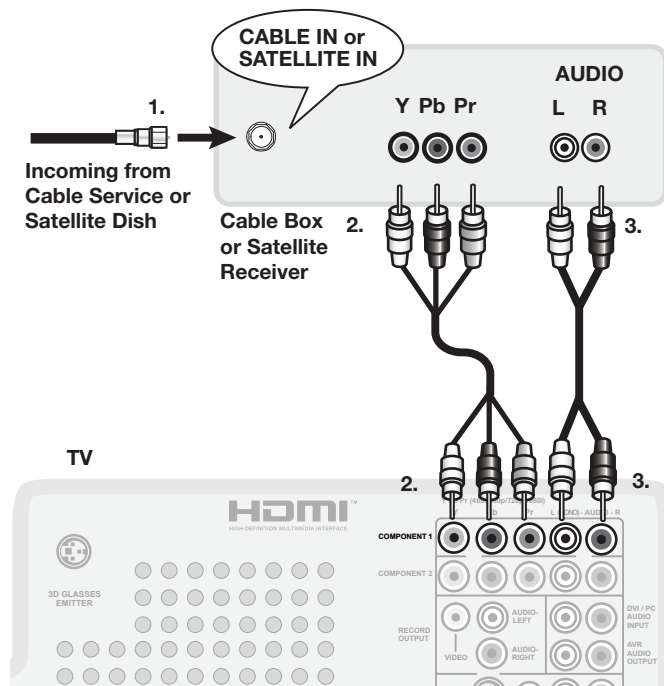

Figure 1. Connecting an external HDTV receiver with component video connections

HDMI Device (Cable Box, Satellite Receiver, DVD Player, or Other Device)

Required: HDMI-to-HDMI cable.

Connect an HDMI cable from the TV back panel to the HDMI device output. HDMI devices provide video and audio through the single cable.

Mitsubishi recommends you use category 2 HDMI cables to connect HDMI 1.3 source devices. High-speed category 2 cables bring you the full benefits of Deep Color and **x.v.Color**. See chapter 1, “TV Overview,” for more on HDMI cable types.

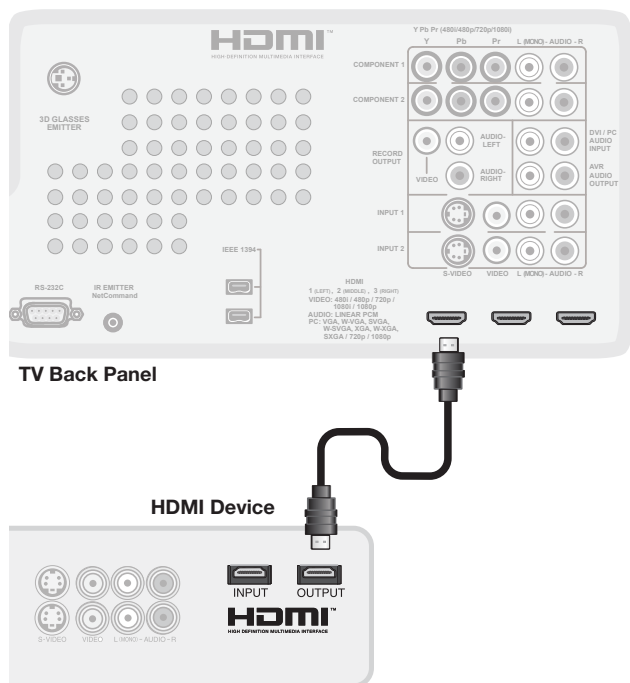

Figure 2. Connecting an HDMI device.

Note: HDMI inputs are **SimpleplayHD** certified for proper interoperability with other products certified by Simpleplay™.

IMPORTANT

HDMI and Audio Signals

- **Digital Surround Sound:** The TV's HDMI inputs can receive digital stereo audio signals only. To hear digital surround sound from an HDMI device, connect the device's digital audio output directly to your A/V receiver. See the Owner's Guides for those devices for instructions.
- **A/V Receiver with HDMI.** If your A/V receiver has an HDMI input, use the audio connections described in “A/V Receiver (Sound System)” instead.

Standard Cable Box, Satellite Receiver, or Other Device with S-Video

Required: S-Video cable and left/right analog stereo audio cables.

1. Connect the cable from the outside cable or satellite service to **CABLE IN** or **SATELLITE IN** on the cable box or satellite receiver.
2. Connect an S-Video cable from **S-VIDEO OUT** on the cable box or satellite receiver back panel to **INPUT S-VIDEO** on the TV back panel.
3. Connect left (white) and right (red) audio cables from **AUDIO OUT** on the cable box or satellite receiver to **INPUT AUDIO L (MONO)** and **R** on the TV back panel.

Note: Refer to the cable box or satellite receiver Owner's Guide for cable or dish antenna connections to the receiver.

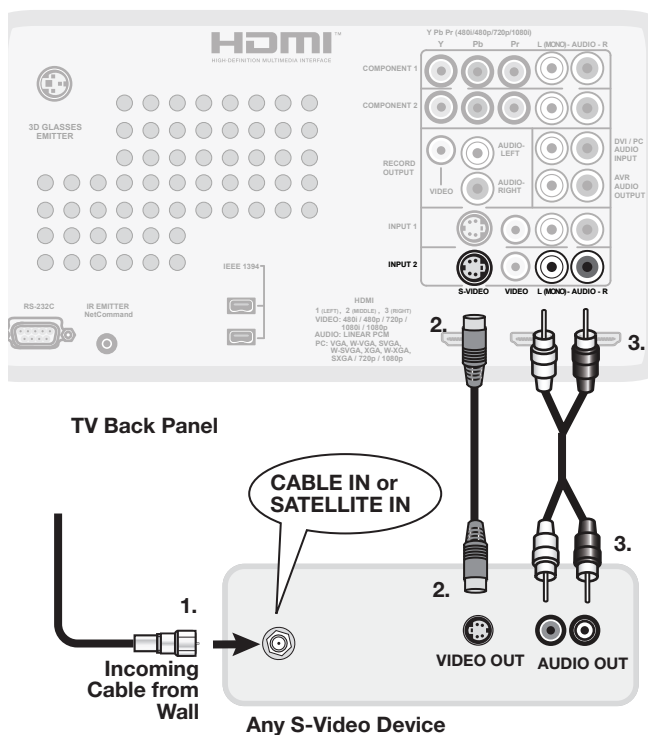

Figure 3. Connecting a device with S-Video

Wall Outlet Cable (no cable box)

It is very important to connect the incoming cable for your primary viewing source to **ANT 1/MAIN**.

1. Connect the primary incoming coaxial lead cable to **ANT 1/MAIN** on the TV back panel.
2. For an optional secondary antenna source, connect an antenna (or cable) to **ANT 2/AUX**.

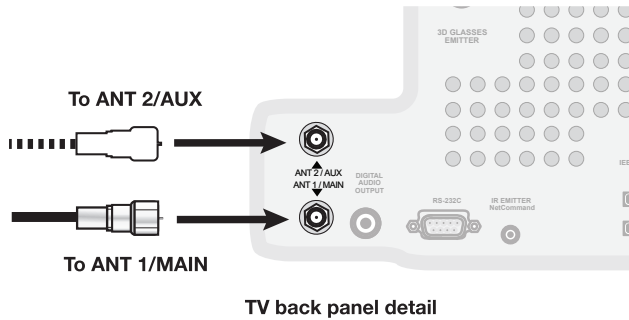

Figure 4. Wall Outlet Cable

Antenna with a Single Lead

A. For an antenna with flat twin leads

Required: 300-ohm-to-75-ohm transformer.

- A1. For an antenna with flat twin leads, connect the 300-ohm twin leads to the 300-ohm-to-75-ohm transformer.
- A2. Push the 75-ohm side of the transformer onto **ANT 1** on the TV back panel.

B. For cable or antenna with coaxial lead

Connect the coaxial lead directly to **ANT 1** on the TV back panel.

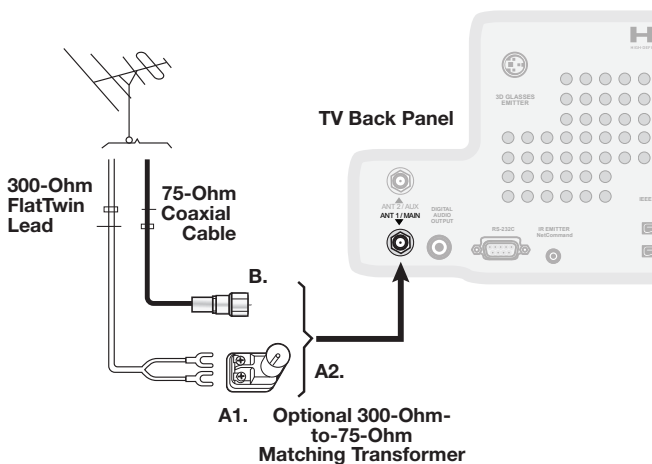

Figure 6. Connecting a Single Antenna Lead

Antennas with Separate UHF and VHF Leads

Required: UHF/VHF combiner

1. Connect the UHF and VHF antenna leads to the UHF/VHF combiner.
2. Push the combiner onto **ANT 1/MAIN** on the TV back panel.

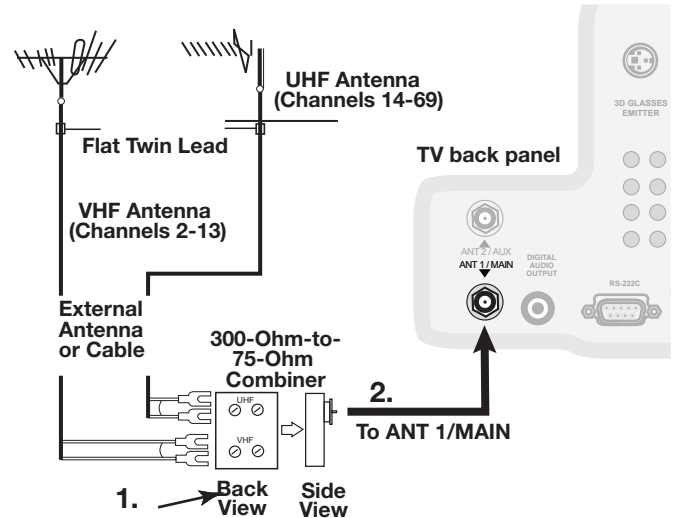

Figure 5. Connecting separate UHF and VHF Antennas

Mitsubishi strongly recommends you avoid using antennas with flat twin leads. Flat twin lead antenna wires are subject to interference which may adversely affect the performance of the TV. We recommend using coaxial antenna cable.

DVD Player with Component Video

Component video cables and analog audio cables are required.

1. Connect the component video cables from **Y Pb Pr VIDEO OUT** on the back of the DVD player to the **COMPONENT** jacks on the TV back panel, matching the green, blue, and red colored connections.
2. Connect left (white) and right (red) stereo audio cables from **AUDIO OUT** on the back of the DVD player to **COMPONENT AUDIO L (MONO)** and **AUDIO R** on the TV back panel.

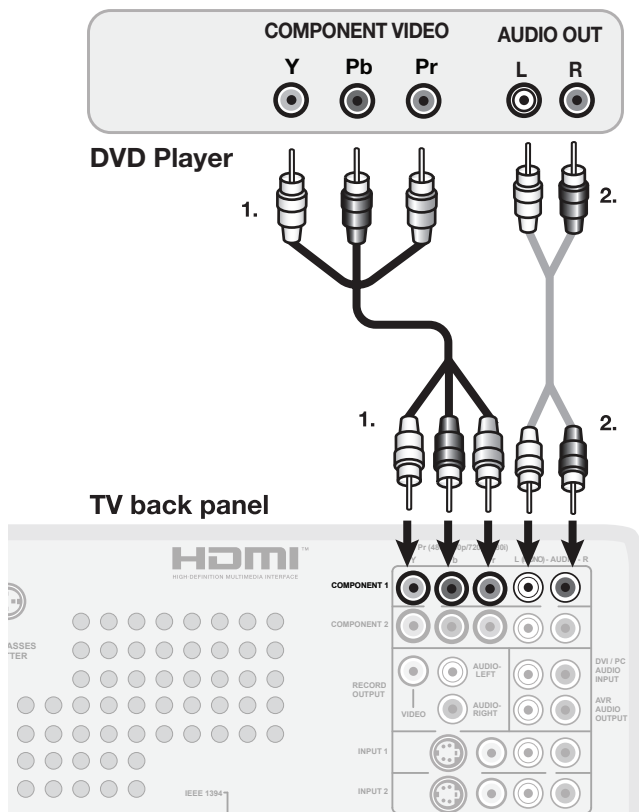

Figure 7. Connecting a DVD player with component video

Note: To hear digital surround sound from your DVD player, connect the digital audio output from the DVD player directly to your digital A/V receiver.

IMPORTANT

See Appendix A for component video signal compatibility information.

For digital audio connections to your A/V receiver, see your DVD player and A/V receiver Owner's Guides.

DVI Video Device (Cable Box, Satellite Receiver, DVD Player, or Other Device)

Connect DVI devices (digital only) to the TV's HDMI input jacks.

Analog stereo audio cables and a DVI-to-HDMI cable or DVI/HDMI adapter and HDMI cable are required.

1. Connect the DVI-to-HDMI cable (recommended) or HDMI cable with DVI/HDMI adapter from the DVI device's back panel to the TV's HDMI jack.

Note: If you are using a DVI/HDMI adapter, it is important to connect the adapter to the DVI device for best performance.

2. Connect a set of audio cables from **AUDIO OUT** on the DVI device back panel to the **DVI/PC AUDIO INPUT** on the TV back panel. Connect the red cable to the **R** jack and the white cable to the **L (MONO)** jack.

Note: The HDMI connection supports copy protection (HDCP).

Some devices require connecting to an analog input first, in order to view on-screen menus and to select DVI as the output. Please review your equipment instructions for DVI connectivity and compatibility.

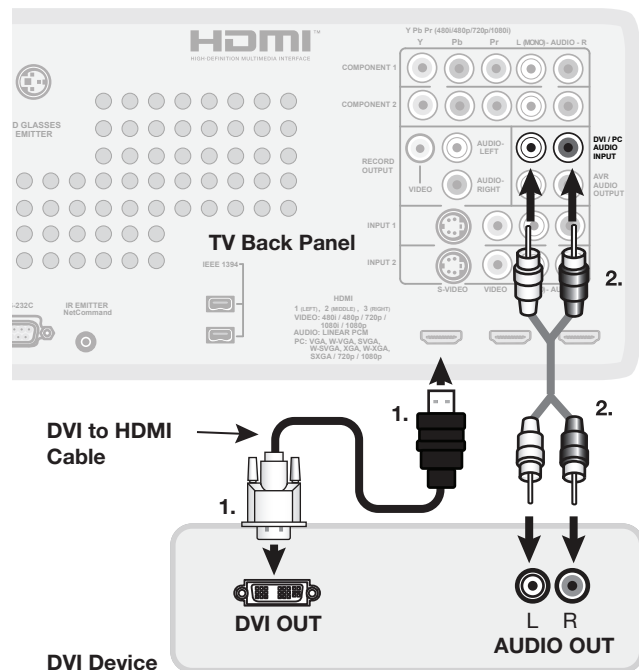

Figure 8. Connecting a digital DVI device

VCR to an Antenna or Wall Outlet Cable

Required: Two-way RF splitter, two coaxial cables, right and left analog audio cables, either S-video or video cable.

1. Connect the incoming cable or antenna to **IN** on the RF splitter.
2. Connect one coaxial cable from **OUT** on the RF splitter to **ANTENNA IN** on the VCR back panel.
3. Connect one coaxial cable from **OUT** on the RF splitter to **ANT 1/MAIN** on the TV back panel. This connection also allows you to use the TV Guide On Screen and Split Screen features.
4. To use the TV speakers with the VCR, connect left (white) and right (red) audio cables from **AUDIO OUT** on the VCR to **INPUT AUDIO L (MONO)** and **AUDIO RIGHT** on the TV back panel. If your VCR is mono (non-stereo), connect only the white (left) cable.
5. Connect either an S-Video or composite video cable from **VIDEO OUT** on the VCR back panel to **INPUT VIDEO** or **S-VIDEO** on the TV back panel. Connect only one type of video cable; S-Video is recommended, if available.

Optional

Perform these two additional steps to:

- Use the TV Guide On Screen recording feature
 - Record high-definition digital channels converted to analog standard-definition video and analog stereo audio
6. Connect left (white) and right (red) audio cables from **AUDIO IN** on the VCR to **RECORD OUTPUT AUDIO LEFT** and **AUDIO RIGHT** on the TV back panel. If your VCR is mono (non-stereo), connect only the white (left) cable.
 7. Connect a composite video cable from **VIDEO IN** on the VCR back panel to **RECORD OUTPUT VIDEO** on the TV back panel.

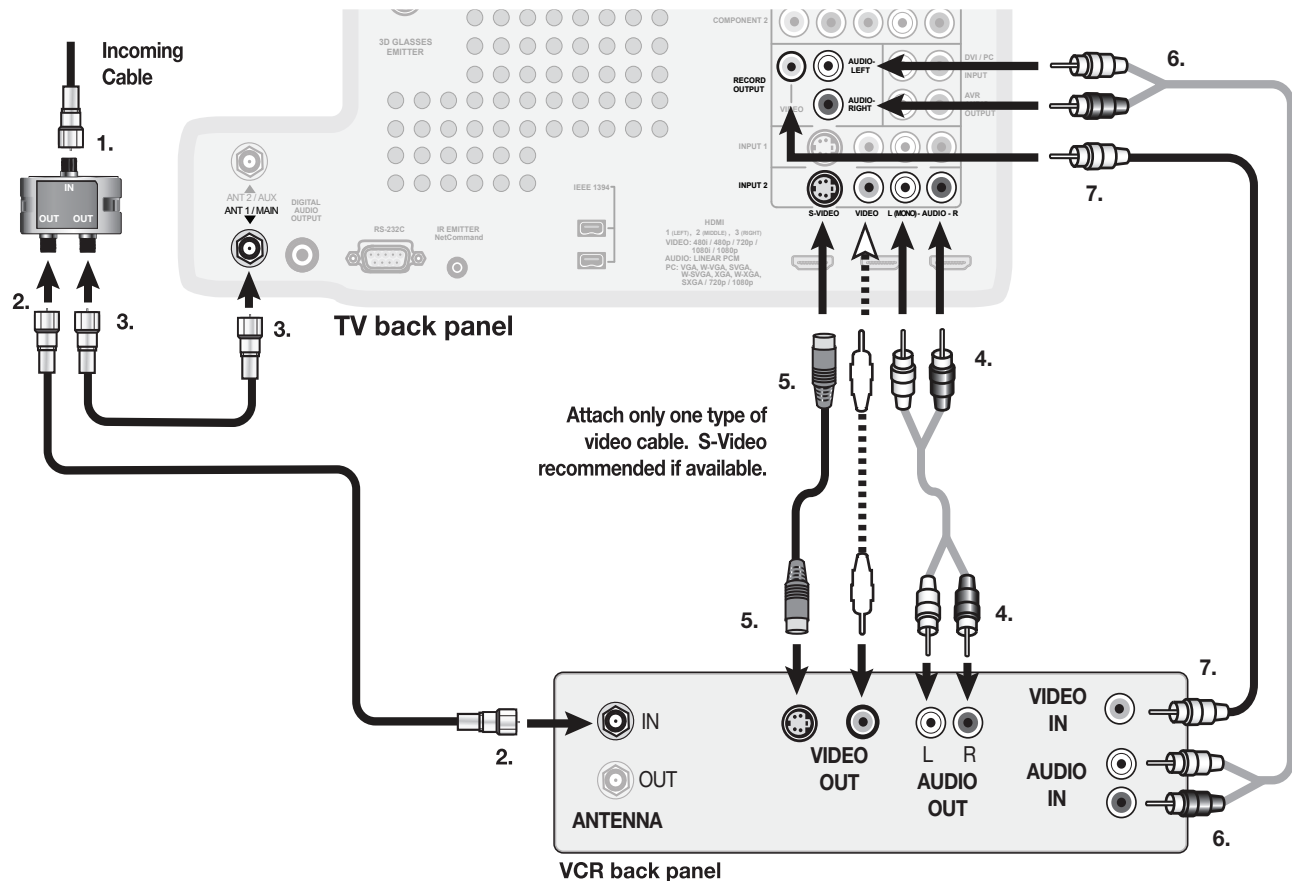

Figure 9. Connecting a VCR to an Antenna or Wall Outlet Cable

VCR to a Cable Box (Audio & Video)

Required: Two-way RF splitter, three coaxial cables, right and left audio cables, S-Video or composite video cable, plus component or S-Video cables and audio cables required to connect the TV to the cable box.

1. Connect the incoming cable to **IN** on the RF splitter.
2. Connect one coaxial cable from **OUT** on the RF splitter to **CABLE IN** on the cable box.
3. Connect one coaxial cable from **OUT** on the RF splitter to **ANT 1/MAIN** on the TV back panel. This connection also allows you to use the TV Guide On Screen and Split Screen features.
4. Connect one coaxial cable from **OUT** on the cable box to **ANTENNA IN** on the VCR back panel.
5. Connect the cable box outputs to the TV as shown in one of the options listed below. This connection allows the TV to receive the best available signal directly from the cable box. See the referenced figures in this chapter, "TV Connections."

- **Figure 1:** Component video output to the TV's **COMPONENT Y Pb Pr** jacks; analog stereo audio to the associated **AUDIO** jacks.
- **Figure 2:** HDMI output to the TV's **HDMI** jack.
- **Figure 3:** S-Video output to the TV's **INPUT S-VIDEO** jack; analog stereo audio to the associated **AUDIO** jacks.

6. To use the TV speakers with the VCR, connect left (white) and right (red) audio cables from **AUDIO OUT** on the VCR back panel to **INPUT AUDIO L (MONO)** and **R** on the TV back panel. If your VCR is mono (non-stereo), connect only the white (left) cable.
7. Connect either an S-Video or composite video cable from **VIDEO OUT** on the VCR back panel to **INPUT/VIDEO** or **INPUT S-VIDEO** on the TV back panel. Connect only one type of video cable. S-Video is recommended, if available.

Optional

8. To use the TV Guide On Screen recording feature to record to the VCR from **ANT 1** or **ANT 2**:
 - a. Connect left (white) and right (red) audio cables from **AUDIO IN** on the VCR back panel to **RECORD OUTPUT/ AUDIO LEFT** and **AUDIO RIGHT** on the TV back panel.
 - b. Connect a video cable from **VIDEO IN** on the VCR back panel to **RECORD OUTPUT VIDEO** on the TV back panel.

Note: When using this connection configuration with the connections used in step 5, it is possible to view live cable programs through the VCR Device. For best picture quality always view live cable programs directly from the TV input connected to the cable box device.

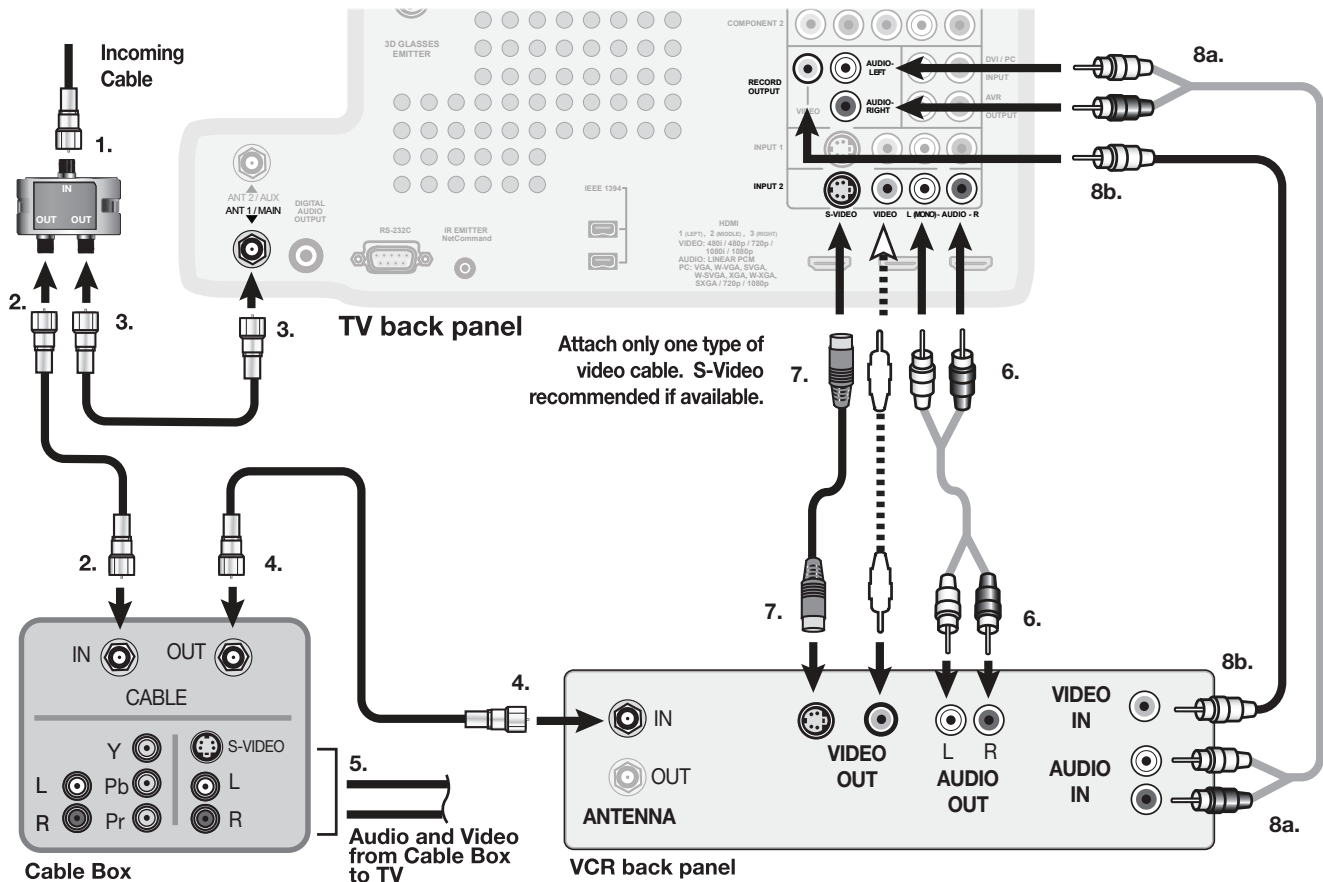

Figure 10. Connecting a VCR to a cable box

A/V Receiver (Sound System)

Most setups require either a digital audio cable or analog stereo audio cables.

The TV makes all audio available in digital and analog formats:

- Analog audio coming into the TV is available as output in digital stereo format on the **DIGITAL AUDIO OUT** jack.
- Digital incoming audio is available as analog output on the **AVR AUDIO OUTPUT/AUDIO L (MONO)** and **AUDIO R** jacks.

Usually, only one of the following connections is required:

- **To connect an analog A/V receiver**
Connect left (white) and right (red) audio cables from **AVR AUDIO OUTPUT/AUDIO L (MONO)** and **AUDIO R** on the TV back panel to the **TV AUDIO INPUT** on the A/V receiver.
- **To connect a digital A/V receiver with Dolby Digital surround sound and PCM audio support:**
Connect one end of the digital audio cable to **DIGITAL AUDIO OUT** on the back of the TV. Connect the other end to the **COAXIAL DIGITAL INPUT** on the back of the A/V receiver.

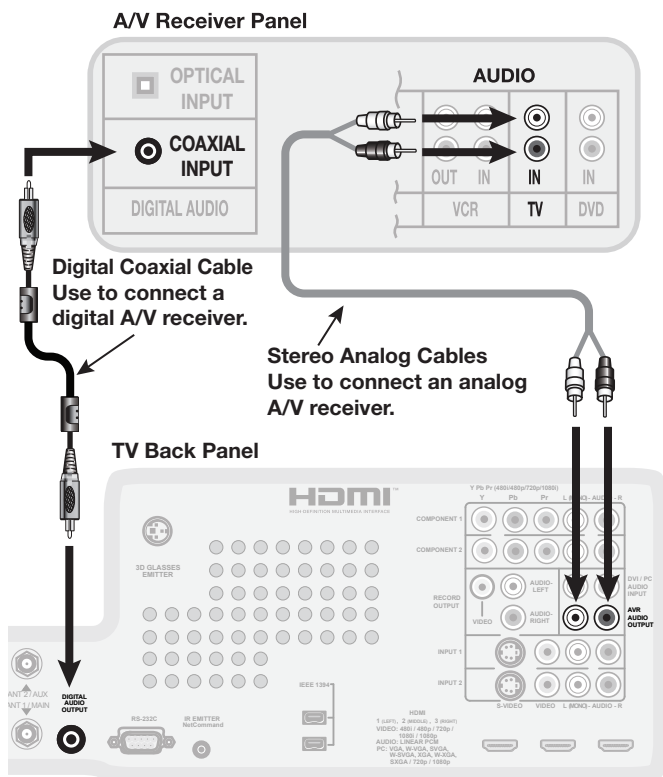

Figure 11. Connecting the TV to an A/V receiver

Important
A/V Receivers with HDMI Inputs
If your A/V receiver has an HDMI input, use one of the audio connections described here instead of an HDMI connection.

Note:

- On rare occasions, an HDMI signal may be copy-protected and cannot be output from the TV as a digital signal. To hear these copy-protected signals through the A/V receiver, use connections for analog A/V receivers.
- Check the A/V receiver's Owner's Guide for information concerning use of the digital input and switching between digital sound and analog stereo sound from the TV.

Older Cable Box

Required: One coaxial cable.

Note: This connection is not recommended. The other connections described in this chapter provide better quality audio and video to the TV and allow NetCommand to work with the cable box.

1. Connect the incoming cable to **IN** on cable box.
2. Connect one coaxial cable from **OUT** on the cable box to **ANT 1/MAIN** on the TV back panel.

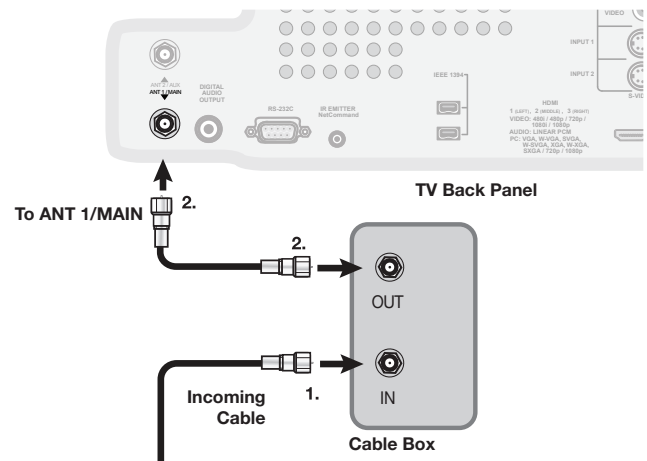
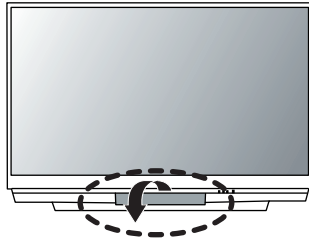

Figure 12. Connecting an older cable box

Camcorder

Inputs on the front of the TV offer the most convenient way to connect a camcorder.

Use jacks on the TV front panel to connect a camcorder



Composite Video Connection

Required: Analog stereo audio and composite video cables supplied with the camcorder.

1. Connect a composite video cable from **VIDEO OUT** on the camcorder to **INPUT 3/VIDEO** or **VIDEO/Y** on the TV.
2. Connect left (white) and right (red) audio cables from **AUDIO OUT** on the camcorder to **INPUT 3/AUDIO L** and **AUDIO R** on the TV.

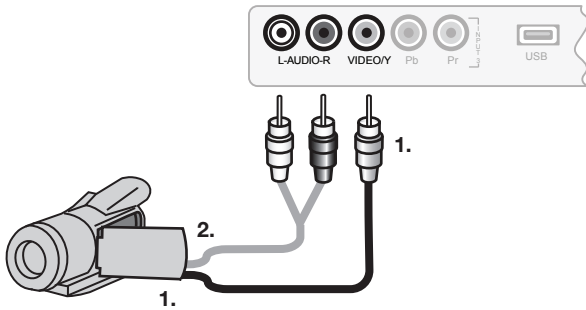

Figure 13. Composite video connections for a camcorder

Component Y Pb Pr Video Connection

Required: Analog stereo audio and component video cables supplied with the camcorder.

1. Connect component video cables from **VIDEO OUT** on the camcorder to the TV's **INPUT 3 COMPONENT** jacks on the front panel.
2. Connect left (white) and right (red) audio cables from **AUDIO OUT** on the camcorder to **AUDIO L** and **AUDIO R** on the TV.

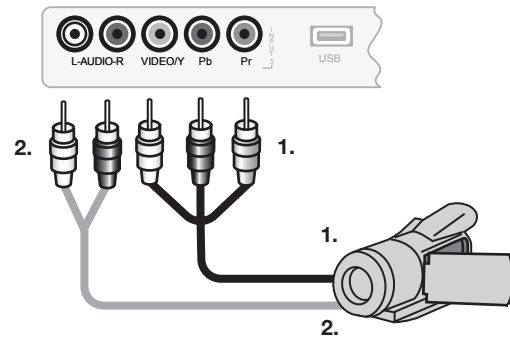

Figure 14. Component video connections for a camcorder

HDMI Connection

Required: HDMI cable supplied with the camcorder.

Connect the camcorder to the TV's **HDMI 4** jack on the front panel.

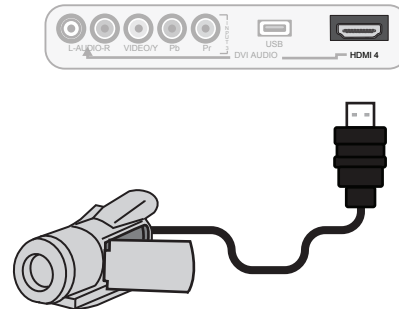

Figure 15. HDMI connection for a camcorder.

IEEE 1394 Devices

Compatible IEEE 1394 Devices

Compatible A/V devices include some, but not all, cable boxes, D-VHS VCRs, A/V discs, camcorders, and future products. Some devices may have IEEE 1394 connectors but are not compatible with the TV. Areas of compatibility to consider are:

1. Digital Video Signals

This TV can decode HDV (high-definition MPEG2 resolution) as provided by cable boxes and some camcorders. The TV cannot decode DV (standard-definition resolution video). If the TV is unable to decode the digital signal supplied by your camcorder, connect the camcorder to the TV using analog audio plus composite video, S-video, or component video, or use HDMI audio/video. Other types of digital video, such as PC video provided by some computers, must be decoded by the source device and sent to the TV as analog video, S-video, or DVI/HDMI video.

2. Digital Audio Signals

When received with video signals, the TV can decode Dolby Digital signals and MPEG audio signals.

The TV may be unable to pass incompatible digital audio signals on the coaxial digital audio output. These signals may pass to other devices, however, on IEEE 1394 cables.

3. Digital Control Signal

The TV can serve as the control center for IEEE 1394 audio/video devices, such as VCRs, A/V Discs, tuners, and cable boxes that are compatible with the following IEEE 1394 control standards.

- **CEA-775.** Designed for tuning devices such as cable boxes, allowing the device to send simple graphics. This standard does not, however, allow the TV to control the cable box by IEEE 1394.
- **AV/C (Audio Video Control).** Designed to provide basic controls such as play, stop, channel selection, and volume, as appropriate for the device.

Four-Pin and 6-Pin Connections

There are two different types of connectors used for IEEE 1394 terminals and cables: a 4-pin and a 6-pin type. Both types send the same digital audio, video, and control signals, but the 6-pin connectors can also supply low-voltage electrical power to connected devices. This TV uses only 4-pin type connectors.

A 6-pin connector cannot be connected directly to a 4-pin jack, and vice versa. To connect a 6-pin device to a 4-pin device, use a 6-pin-to-4-pin adapter or adapter cable. These cables are available from electronics and computer stores.

If you wish to connect a 6-pin device to the TV (such as a camcorder), and the device is designed to receive

electrical power from another 6-pin device, there are several ways to provide electrical power to the device:

- Connect the camcorder directly to the household AC.
- Use the camcorder's battery for power.
- Connect the camcorder directly to another 6-pin device in the network that can provide power.



4-pin connector 6-pin connector 6-pin-to-4-pin adapter

Connection Methods

There are two connection methods for IEEE 1394 devices. Use the method that fits your network of audio/video products.

Direct Device-To-Device Method

The IEEE 1394 interface allows you to chain devices, unlike audio and video connections that require you to connect each individual device directly to the TV. For example, you can connect your D-VHS to your 1394 A/V disc and then connect the 1394 A/V disc to the TV. The resulting IEEE 1394 chain allows you to add more devices to the chain. You will see an icon for each device in the TV's Input Selection menu and can also send information from any IEEE 1394 device to other compatible devices.

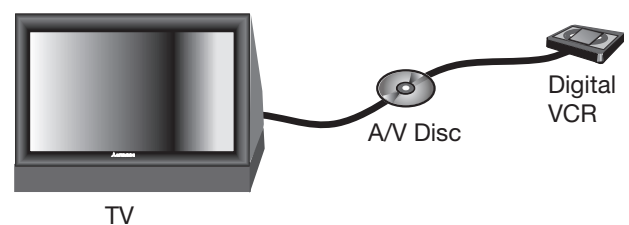

Hub Connection Method

The IEEE 1394 standard allows you to use the TV as a hub within the audio/video network. Each device can send information, which may include audio and video, to any other device in the network.

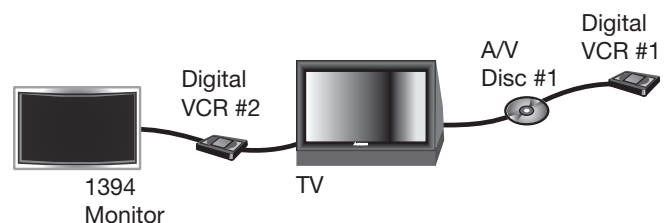

IEEE 1394 Devices, continued

Tips for Connecting IEEE 1394 Devices

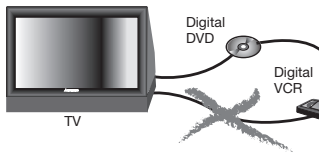
- Do not loop the last device in the chain back to the TV. When the device chain is looped, the TV may not be able to work with the other devices. 
- Place devices that have only a mechanical (two-position) power switch at the end of the chain or leave the power switch in the on position. When turned off, IEEE 1394 signals may not be able to pass through the device to other devices.
- Place devices with the slowest communication speed at the end of the chain. Sometimes the communication speed is marked near the IEEE 1394 connector with an “S” number. The higher the number, the faster the communication speed. This TV has a communication speed of s400. Devices with slow communication speeds can interfere with IEEE 1394 signals from faster devices. When setting up a digital recording between a faster device and a slower device, make the slower device the source and make the faster device the recorder.
- Use IEEE 1394 cables 15 feet or less in length between devices.
- This TV is an IEEE 1394a device. It can be used with an IEEE 1394b system when an IEEE-1394a-to-1394b convertor is used. IEEE 1394b systems are capable of greater distances and multi-room applications.
- The TV can recognize a maximum of seven IEEE 1394 devices at any one time.

IEEE 1394 Camcorders

- **Control Functions.** Connect the camcorder to an IEEE 1394 jack on the rear of the TV and test using the TV’s remote control to operate the camcorder. If your model does not operate properly, use the camcorder’s control buttons instead.
- **MPEG Camcorders.** If you are unable to play back over the IEEE 1394 interface, use the analog audio/video connections described in chapter 3, “TV Connections.”

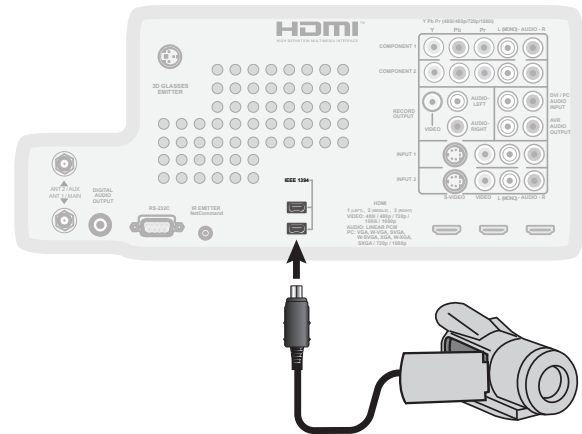

You can connect an IEEE 1394 camcorder with an IEEE 1394 cable as shown above or with analog audio/video cables.

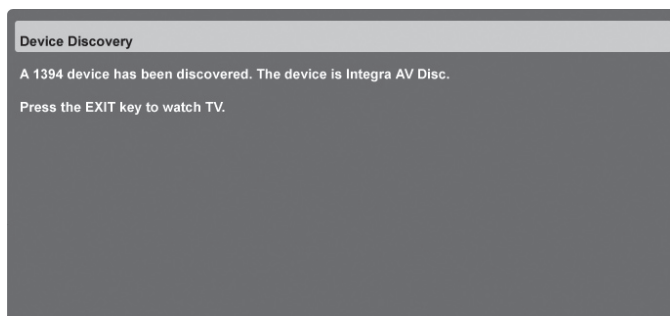

Auto Input Sensing screen for an IEEE 1394 device.

4 TV Operation and Features

Choosing a Viewing Source



Input Selection menu

Choose a viewing source from the **Input Selection** menu. The current TV input appears as a full-color icon in this menu.

1. Press **INPUT** to display the **Input Selection** menu. If there are only two inputs to the TV, **INPUT** switches between them without displaying the menu.
2. Highlight an input icon using **▲ ▼ ◀ ▶**.
3. Press **ENTER** to switch to the input and close the menu.

More About the Input Selection Menu

- To assign meaningful names to the icons, see the **Inputs > Name** menu in chapter 5, “TV Menu Settings.”
- To rearrange the icons, see the **Inputs > Order** menu in chapter 5, “TV Menu Settings.”

Sleep Timer

The Sleep Timer turns the TV off after the length of time you set.

Setting the Sleep Timer

1. Press **SLEEP** on the remote control.
2. Press **SLEEP** additional times to increase the time in 30-minute increments up to the maximum of 120 minutes.
3. Press **EXIT** or wait five seconds without pressing any buttons for the message to disappear.
4. Press **SLEEP** to view the time remaining before the sleep timer turns off the TV.

Cancelling the Sleep Timer

1. Press **SLEEP** to display the on-screen message.
2. Press **SLEEP** repeatedly until **OFF** is displayed.

Note: After five seconds of inactivity, the message box will disappear.

TV Tips

Turning the TV On or Off

To turn the TV on or off, point the remote control at the front of the TV and press the **POWER** button. Alternatively, press the **POWER** button on the front panel of the TV.

If You Turn Off the TV by Mistake

1. Press **POWER** again within about 30 seconds, while the lamp is still hot, to have the TV come back on immediately.
2. If the **LAMP** indicator starts blinking (about 30 seconds after you shut off power), **wait about 35 seconds for the LAMP indicator to stop blinking and press POWER to turn the TV on again.**

Controlling Sound Volume

Press **VOL ▲/▼** to adjust the sound level. See also “Controlling A/V Receiver Sound Volume” in chapter 2, “TV Setup.”

Changing Channels (antenna sources)

To change channels:

- Enter the channel number using the number keys on the remote control and press **ENTER**. For a two-part digital channel, such as 3-1, press **3** **CANCEL** **1** to enter a dash (separator).
- Press **CH/PAGE ▲/▼** to change channels one channel at a time.
- Press and hold **CH/PAGE ▲/▼** to move quickly through channels.
- Press **QV** (QuickView) to switch back to the previously tuned channel.
- Press **GUIDE** to display ChannelView or TV Guide On Screen channel listings, highlight a channel, and press **ENTER**.
- Use the Fav (Favorites) feature to set up lists of favorite channels and tune to them with the **FAV** key. See “Setup Menu” in chapter 5.

NOTE: Perform channel memorization to make finding channels easier. See the **Setup > Scan** menu.

Remote Control

1. **POWER:** Turns TV power on and off.
2. **Slide Switch:** Selects the A/V device to be operated by the remote control. Set the slide switch to TV for operation of the TV, NetCommand-controlled devices, and IEEE 1394 devices. Control of additional devices requires programming (see Appendix D, "Programming the Remote Control.")
3. **SLEEP:** Sets the TV to turn off within 2 hours.
4. **Digits/Letters:** Press digits for channel numbers, then press **ENTER** for faster tuning. Use numbers and the **CANCEL** key to enter digital sub-channel numbers. Use also for entering letters or names in menus. To select letters when naming channels, repeatedly press the associated number key. Press **ENTER** to set the letter. Special characters are available with the 1 key (!, &, blank space) and 0 key (/ , * , -).
5. **-/CANCEL (SUB-CHANNEL/CANCEL):** When entering digital channel numbers, adds a separator between main and sub-channel numbers. Clears Fav and some menu entries.
6. **QV (QuickView™):** Switches between the current channel and the last channel viewed.
7. **MUTE:** Turns TV sound on and off.
8. **SPLIT:** Turns Split Screen mode on and off.
9. **FAV (Favorites):** Scans through memorized lists of favorite channels. See "Setup Menu" in chapter 5, "TV Menu Settings," for more information.
10. **VOL \wedge/\vee (Volume Up/Down):** Changes sound level.
11. **CH/PAGE \wedge/\vee (Channel or Page Up/Down):** Scans up or down through memorized channels. Pages up and down through screens when used with the TV Guide On Screen system or ChannelView™.
12. **FORMAT:** Changes the shape and size of the TV picture. When in Split Screen mode, changes the size of the split images while maintaining their aspect ratios.
13. **LIST:** Works like the **LIST** key for a cable box or satellite receiver when "learned" for NetCommand or when the remote has been programmed for the device.
14. **INPUT:** Displays the **Input Selection** menu from which you can select an input source to view, such as an antenna input (**ANT 1/2**) or a connected device.
15. **$\blacktriangle \blacktriangledown \blacktriangleleft \blacktriangleright$ (Adjust Up/Down/Left/Right):** Navigate menus and change settings.
16. **ENTER:** Selects a channel number or menu item.
17. **GUIDE:** Displays or removes ChannelView™ channel listing for **ANT 1** and **ANT 2**. With the TV Guide On Screen system enabled, launches TV Guide On Screen. Displays DVD disc or top menu for a NetCommand-controlled DVD player.

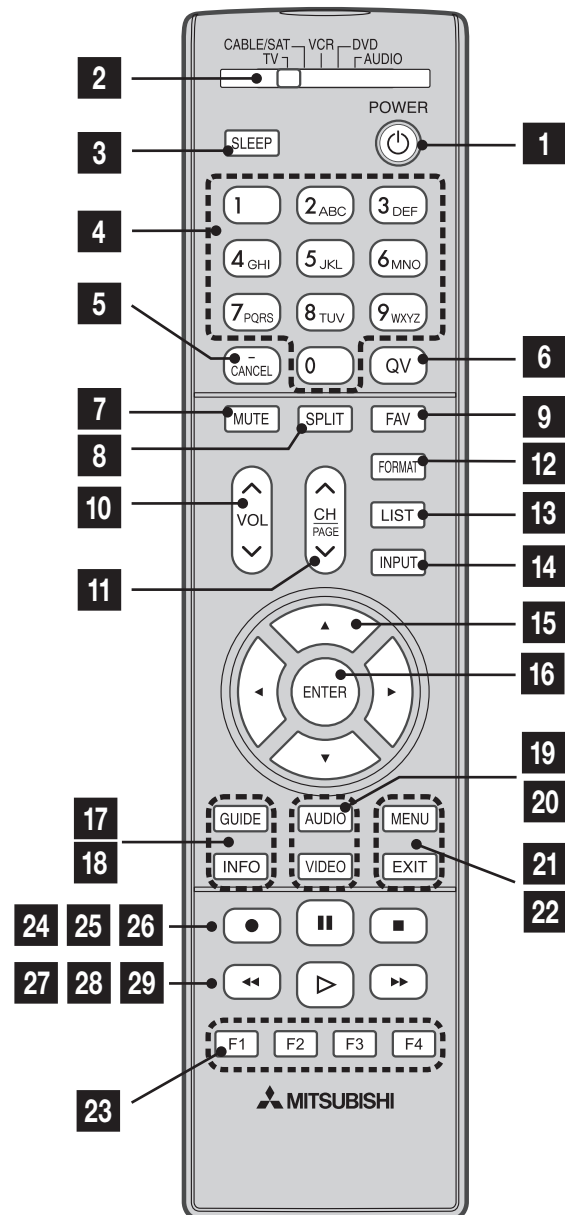

18. **INFO:** Displays an on-screen summary of the current device in use and any broadcast information available, including current V-Chip ratings information. See chapter 4, "TV Operation and Features," for details.
19. **AUDIO:** Selects individual audio settings to adjust.
20. **VIDEO:** Selects individual video settings to adjust.
21. **MENU:** Displays the main TV menu. When a sub-menu is open, backs up one menu level.
22. **EXIT:** Closes TV on-screen menus/displays.

Remote Control, continued

23. F1-F4

For devices under NetCommand control: Perform NetCommand “Learning” to assign your choice of functions to the F1–F4 keys.







For devices operating independently of NetCommand: The F1–F4 keys work like the A, B, C, D buttons on some cable boxes, satellite receivers, and DVD players. Program the remote control for your equipment and test the keys. See Appendix D, “Programming the Remote Control.”

25.  (PAUSE): Freezes a broadcast TV picture when no Split Screen image is displayed. When Split Screen is displayed, freezes the sub-picture.

Record/Playback Keys

Use any of these methods to enable the recording and playback commands:

- Program the remote control for your DVR, VCR, or DVD player/recorder and set the slide switch to **VCR**, **DVD**, **CABLE/SAT**, or **AUDIO** as appropriate.
- Perform NetCommand IR “learning” for the device.
- For control of IEEE 1394 devices, see chapter 6, “NetCommand.”
- Check HDMI devices for compatibility with the TV’s NetCommand for HDMI feature (see below).

24.  (RECORD): Records with a VCR or DVR.
25.  (PAUSE): Pauses a VCR, DVR, or DVD. See above for use during TV viewing.
26.  (STOP): Stops play of a VCR, DVR, or DVD.
27.  (REVERSE): Rewinds a VCR. Reverse scans a DVR or DVD.
28.  (PLAY): Plays a VCR, DVR, or DVD.
29.  (FORWARD): Fast forwards a VCR. Forward scans a DVR or DVD.

Note: To operate other audio/video devices using the TV’s remote control:

- See Appendix D, “Programming the Remote Control.”
- See chapter 6, “NetCommand,” for NetCommand IR “Learning” of device keys.
- For control of IEEE 1394 devices, see chapter 6, “NetCommand.”
- For HDMI devices compatible with the TV’s NetCommand for HDMI feature, see “NetCommand for HDMI Devices” on this page.







NetCommand for HDMI Devices

The TV’s remote may operate some functions of compatible HDMI devices able to receive commands through the HDMI cable. Test your equipment with the TV’s remote to find out which commands are supported. See below for commands that may be available, depending on the individual device. You can add commands using NetCommand IR “learning” after connecting and placing IR emitters for the devices.

Press **PLAY** on the device itself to:

- Turn on the TV if not already on
- Switch to the device (no need to display the **Input Selection** menu)
- Begin play of the device

VCR, DVD, and DVR functions that may be available:

Record/ Playback	Menu Navigation	Channel Tuning	Other
		CH 	GUIDE
	ENTER	Digits 0-9, 	F1 (content)
	 (to cancel)	ENTER	MENU

Resetting the Remote Control

If the slide switch is set to **TV** and the TV does not respond properly, reset the remote control.

1. Press and hold **POWER** for several seconds until the button blinks twice and goes off.
2. Release the **POWER** button.
3. Press keys **0 0 9 3 5** and the **POWER** button will blink twice when you finish entering the code. While entering the code, pause for a moment between each key press to ensure it is recognized.

Low-Battery Indicator

If you press a key and the **POWER** key blinks five times, replace the remote control’s batteries.

Care of the Remote Control

- Use only alkaline batteries.
- Be within 20 feet of the equipment.
- Do not press two or more buttons at the same time unless instructed to do so.
- Do not allow unit to get wet or become heated.
- Avoid dropping on hard surfaces.
- Do not use harsh chemicals to clean. Use only a soft, lightly moistened cloth.
- Do not mix old and new batteries.

ChannelView Channel Listings

CHANNEL VIEW	ChannelView™ Ant-1	5:47 pm, Fri., July 25
2	CBS	Programs for KCET-DT
2.1	KCBS-DT CBS Local News	5:30 PM Nightly Business Re...
4		6:00 PM NewsHour with Jim ...
4.1	KNBC-DT NBC World News	7:00 PM Life and Times
7	ABC	7:30 PM California's Gold
7.1	KABC-DT ABC World News	8:00 PM Washington Week
28	PBS	8:30 PM Wall Street Week wit...
28.1	KCET-DT The Rose Parade	9:00 PM Now with Bill Moyers
28.2	KCET-DT Nightly Business Re...	10:00 PM Culture of Hate: Wh...
32		11:00 PM Tavis Smiley

In addition to reporting on the day's breaking business, economic and market news, Nightly Business Report features commentators, special ...

ChannelView screen

ChannelView™ shows memorized channels on **ANT 1** or **ANT 2**. It displays channel names and program information as sent by broadcasters or your local cable service provider and may be incomplete. No program information is displayed for analog channels. An analog channel name is displayed only if you assigned a name in the **Setup > Edit** menu.

- You can use either ChannelView or the TV Guide On Screen system to see channel listings. ChannelView is accessible via the **GUIDE** key unless you activate the TV Guide On Screen system. For details, see the separate *TV Guide On Screen Interactive Program Guide User's Manual*.
- To receive ChannelView updates:
 - Keep the Energy Mode set to **Fast Power On**
 - Set the TV clock
 - Leave the TV powered off for a while each day to receive updates.

Note: Whenever you watch a digital channel, listings are updated for the channel you are watching.

Using ChannelView

Feature	Press Key
See ChannelView listings from ANT 1 or ANT 2 .	Press GUIDE .
Close ChannelView	Press GUIDE or EXIT .
Scan channels one by one.	Press and hold ▲ or ▼ .
Scan channels quickly.	Press and hold PAGE ^ / v .
Jump to listings for a specific channel.	1. Enter the channel number (see numbers in upper left of screen). 2. Press ENTER .
See more of the program description (if available).	Press INFO .
Move navigation to the program guide.	Press ▶ .
Move navigation to the channel guide.	Press ◀ .
Tune to the highlighted channel.	Press ENTER .

Status Display

Press the **INFO** key to see the on-screen status display. The most common displays are shown here. Seldom or never do all the status indicators appear at the same time.

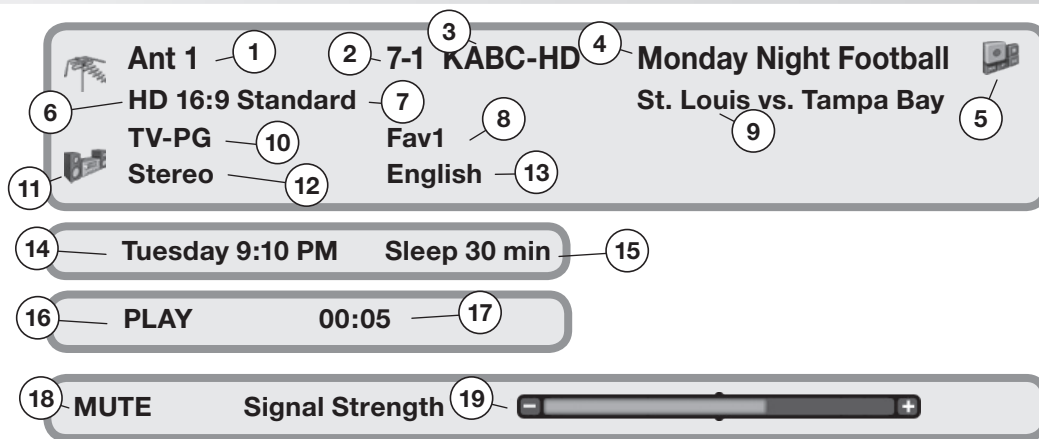

On-screen status display sample information

Analog Sources	Digital Sources
1. Source antenna or input	Source antenna or input
2. Analog channel being received (antenna sources only)	Digital major and sub-channel numbers (antenna sources only)
3. Analog channel name (if named in the Setup > Edit menu or provided by TV Guide On Screen); antenna sources only.	Digital Channel Name (if broadcast, provided by TV Guide On Screen, or if named in the Setup menu > Edit options; antenna sources only)
4. Program name; displayed only if provided by TV Guide On Screen.	Program name (if broadcast or provided by TV Guide On Screen; antenna sources only)
5. Record icon indicates a recording in progress for this program. Press CANCEL to end the recording.	Record icon indicates a recording in progress for this program. Press CANCEL to end the recording.
6. Signal Type Being Received. Possible: On antenna sources or INPUT 1-3 : 480i On component jacks: 480i, 480p, 720p, 1080i	Signal Type Being Received. Possible: On antenna sources: SD 4:3, SD 16:9, HD On HDMI: 480i, 480p, 720p, 1080i, 1080p, all PC resolutions
7. Screen Format in use. Possible: Analog 480i /480p signals: Standard, Expand, Zoom, Stretch, Stretch Plus, Narrow 720p/1080i signals: Standard, Wide Expand	Screen Format in Use. Possible: SD 4:3, 480i, or 480p: Standard, Expand, Zoom, Stretch, Stretch Plus, Narrow SD 16:9 or HD 16:9, 720p, or 1080i: Standard, Wide Expand 1080p: Standard
8. Current Fav bank number of channel (antenna sources only)	Current Fav bank number of channel (antenna sources only)
9. Program description (if supplied by TV Guide On Screen)	Program description (if broadcast); antenna sources only)
10. V-Chip rating (antenna sources or INPUT jacks only)	V-Chip rating (antenna sources or IEEE 1394 devices only)
11. Audio Source. Possible: TV speakers, external sound system	Audio Source. Possible: TV speakers, external sound system
12. Listen To indicator: Stereo, Stereo SAP, SAP (antenna sources only))	Stereo, Surround, Dual Mono (antenna sources only)
13. (Does not apply)	Current language (antenna sources only)
14. Day and time	Day and time
15. Sleep Timer remaining time	Sleep Timer remaining time
16. (Does not apply)	Status of D-VHS or IEEE 1394 device
17. (Does not apply)	Counter of D-VHS VCR or IEEE 1394 device
18. Mute indicator	Mute indicator
19. (Does not apply)	Signal strength indicator (antenna sources only)

Fav (Favorite Channels)

Use the six Fav channel banks to store groups of your favorite channels from **ANT 1** and **ANT 2**. You can set up a Fav channel bank for each of your favorite program types or set up a bank for each TV user.

You may prefer to perform Fav channel setup from a menu. See chapter 5, "TV Menu Settings," and the **Setup > Edit** options.

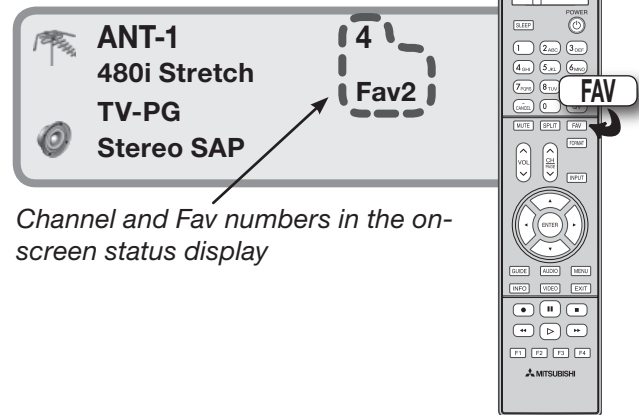

Channel and Fav numbers in the on-screen status display

Using Fav Channels

See the current Fav bank number	Press INFO.
View channels in current Fav bank	<ol style="list-style-type: none"> 1. Press the FAV key. Wait for the TV to tune to a channel in the current Fav bank. 2. Press the FAV key repeatedly to cycle through the channels available in the current Fav bank.
Change Fav banks	<ol style="list-style-type: none"> 1. Press the FAV key. Wait for the TV to tune to a channel in the current Fav bank. 2. When tuning is complete and while the TV status display is still visible on screen, press the number key for the desired bank (1–6). <p>Note: Wait for the channel change to finish before pressing the number key. Otherwise, the TV may ignore the Fav number.</p>
If no Fav banks are set up	The FAV key switches to the previously tuned channel; works like the QV key.

Fav Setup Using Only the Remote Control

Add Fav channels	<ol style="list-style-type: none"> 1. While watching TV, tune to the channel you want to add to the current Fav memory bank. The default bank is Fav1. See the instructions above if you need to change to a different Fav bank. 2. Press and hold the FAV key for about 2 seconds. When Fav and the memory bank number appear under the channel number, the channel has been successfully added.
Remove Fav channels This procedure removes the channel only from the selected bank and leaves the other banks unchanged.	<ol style="list-style-type: none"> 1. While watching TV, press the FAV key. 2. While the TV status display is still visible on screen, press the number key for the memory bank. 3. Press the FAV key repeatedly until you see the desired channel in the on-screen status display. 4. While the channel number and Fav indicator (with correct bank number) are still displayed on the screen, press CANCEL. You must press CANCEL while the indicator is displayed. When the Fav indicator disappears after pressing CANCEL, the channel has been successfully removed.

TV Signals and Display Formats

This is a widescreen TV, also known as a 16:9 TV. This shape reflects the new types of images available from HDTV and many DVDs. There are still many older style narrow-screen images (called 4:3 aspect ratio) you will encounter. While there is no perfect solution for displaying a squarish, narrower image on a wide screen, Mitsubishi offers several display formats from which you can choose.

Press **FORMAT** on the TV remote control to cycle through the available display formats. The last-used format for each device is used when you return to that device.

DVD Definitions

Anamorphic (or Enhanced for WideScreen TV)

These DVDs are recorded in a special way to properly show widescreen images on 16:9 TV sets using the Standard format mode. This is the recommended viewing choice.

Non-Anamorphic (or 4:3, 1:33:1, Letter Box, or Full Screen)

These DVDs are recorded for use with traditionally shaped, squarish TVs. They may be full screen (4:3 or 1:33:1) which crops movies to fit the narrow TV, or letter box, which adds black top and bottom bars.

This information may be listed on the DVD case. Some DVDs support both types of recordings.

Signal Definitions

480i Signals: Traditional interlaced signals from or through **ANT-1** and **2**, **INPUT 1-3**, **COMPONENT** and **HDMI** jacks.

480p Signals: Progressive-scan DVD signals on **COMPONENT** and **HDMI** jacks.

720p and 1080i Signals: High-definition signals received through **COMPONENT** and **HDMI** jacks. These signals are always 16:9 (widescreen).

SD 4:3: Standard-definition squarish-screen format signals from digital channels on **ANT 1** and **ANT 2** and IEEE 1394 devices.

SD 16:9: Standard-definition widescreen format signals from digital channels on **ANT 1** and **ANT 2** and IEEE 1394 devices.

HD: High-definition wide-screen format signals from digital channels on **ANT 1** and **ANT 2** and IEEE 1394 devices. These signals are always 16:9 (widescreen).

TV Display Format Definitions

Standard: This is the full-screen format. HDTV signals use this format. This format is useful for displaying Anamorphic DVDs that have 1.78:1 or 1.85:1 aspect ratios. Anamorphic DVDs that have a 2.35:1 aspect ratio are displayed with black bars at the top and bottom, but show the entire image correctly. Narrow (4:3) images are stretched evenly from side to side. Available for all signals.

Expand: This enlarges the picture to fill the screen, cropping off some of the image at the top and bottom. This is useful for reducing the letter box top and bottom bars of non-anamorphic DVD images. Available for 480i, 480p, and digital SD 4:3 signals only.

Zoom: This enlarges the picture, cropping off some of the image at each side and top and bottom. This is useful for removing or reducing the black top and bottom bars on anamorphic DVDs with a 2.35:1 aspect ratio. Available for 480i, 480p, and SD 4:3 signals only.

Stretch: This format stretches a narrow (4:3) image across the screen; there is less stretch in the center than at the sides, however. This allows the entire narrow image to be displayed across the screen with less distortion than is seen in the Standard format. Available for 480i, 480p, and SD 4:3 signals only.

Stretch Plus: Similar to stretch mode, but to minimize distortions on the side, the picture is expanded to crop off portions of the top and bottom. Except when displaying menus, press **▲▼** to adjust the position of the picture vertically. Available for 480i, 480p, and SD 4:3 signals only.

Narrow: This format displays narrow (4:3) images in their original shape, and adds stationary black side bars to fill the screen. Available for 480i, 480p, and SD 4:3 signals only.

Wide Expand: Enlarges the picture, cropping some of the image on both sides. This Expand format is useful to remove or reduce black side bars added to narrow images that are converted to 16:9 signals for digital broadcast. Available for 1080i, 720p, digital SD 16:9 and digital HD signals; not available for 1080p signals.

Note: All high-definition channels send widescreen (16:9) signals, but not all programming sent on these channels was created for this format. The broadcaster may stretch the image or add side bars to fill the widescreen area.

TV Display Formats

See descriptions on the preceding page.

**ORIGINAL SIGNAL
Non-anamorphic or SD 4:3**

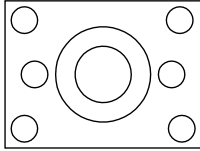

**ORIGINAL SIGNAL
Anamorphic DVD**

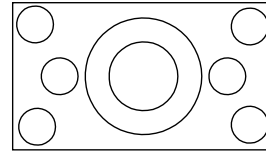

TV Display

Standard

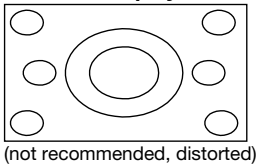

(not recommended, distorted)

TV Display

Standard

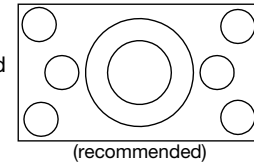

(recommended)

Expand

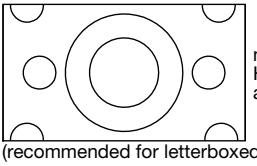

(recommended for letterboxed)

not available for
HD, SD 16:9 or
analog 720p, 1080i

Expand

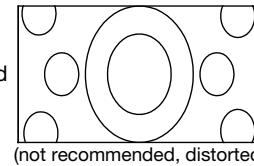

(not recommended, distorted)

not available for
HD, SD 16:9 or
analog 720p, 1080i

Zoom

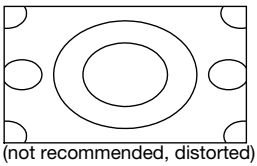

(not recommended, distorted)

not available for
HD, SD 16:9 or
analog 720p, 1080i

Zoom



(recommended for anamorphic 2.35:1)

not available for
HD, SD 16:9 or
analog 720p, 1080i

Stretch

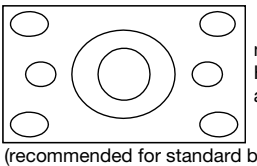

(recommended for standard broadcast)

not available for
HD, SD 16:9 or
analog 720p, 1080i

Stretch



(not recommended, distorted)

not available for
HD, SD 16:9 or
analog 720p, 1080i

Stretch Plus

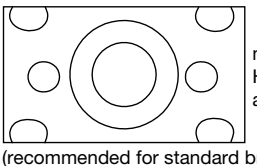

(recommended for standard broadcast)

not available for
HD, SD 16:9 or
analog 720p, 1080i

Stretch Plus

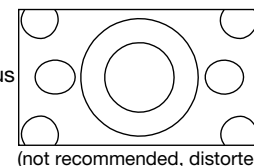

(not recommended, distorted)

not available for
HD, SD 16:9 or
analog 720p, 1080i

Narrow

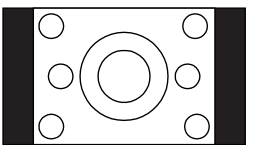

(with side bars in broadcast)

Narrow

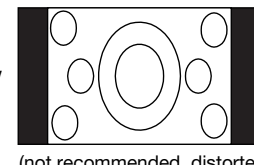

(not recommended, distorted)

not available for
HD, SD 16:9 or
analog 720p, 1080i

**SD 16:9 or
HD Digital**

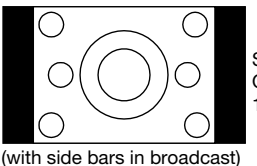

(with side bars in broadcast)

Standard
Original HD or SD
16:9, 720p or 1080i



Wide Expand

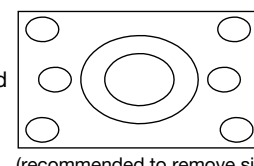

(recommended to remove side bars)

available only for
digital SD 16:9, HD,
analog 1080i or 720p

Split Screen

Split Screen allows you to view pictures from two different sources at the same time. Split Screen is available when you have video sources connected to the TV in addition to connections on **ANT 1** or **ANT 2**.

Operation of Split Screen

Split Screen Operations	Instructions
Turn Split Screen on or off	Press SPLIT .
Switch the sound source between the main picture (left) and sub-picture (right).	Press ◀ or ▶ . The speaker icon (right) appears briefly to indicate the sound source. The sound source is the side you can control with the remote control. 
Check which picture is the sound source.	Press INFO . The speaker icon appears and indicates the sound source.
Change the source of the sub-picture.	<ol style="list-style-type: none"> Press ▶ to make the sub-picture the sound source. Press INPUT to display the Split Screen Input Selection menu. Move the highlight to the icon for the input you wish to view as the sub-picture. Press ENTER to make the change. <p>Grayed-out input icons are unavailable as Split Screen sources or with the current main-picture source.</p>
Change sub-picture channel (when the input source is ANT 1 , ANT 2 , or a NetCommand-controlled cable box or satellite receiver).	<ol style="list-style-type: none"> Press ▶ to make the sub-picture the sound source. Press CH/PAGE ^/∨.
Freeze or unfreeze the sub-picture.	Press ⏸ (PAUSE). Press ⏸ again to return to normal moving video.
Change the size of the main and sub-pictures.	Repeatedly press FORMAT to cycle through picture sizes. See the following page for sample displays.
Make the sub picture fill the screen.	<ol style="list-style-type: none"> Press ▶ to make the sub-picture the sound source. Press SPLIT to close Split Screen mode.

Split Screen Displays

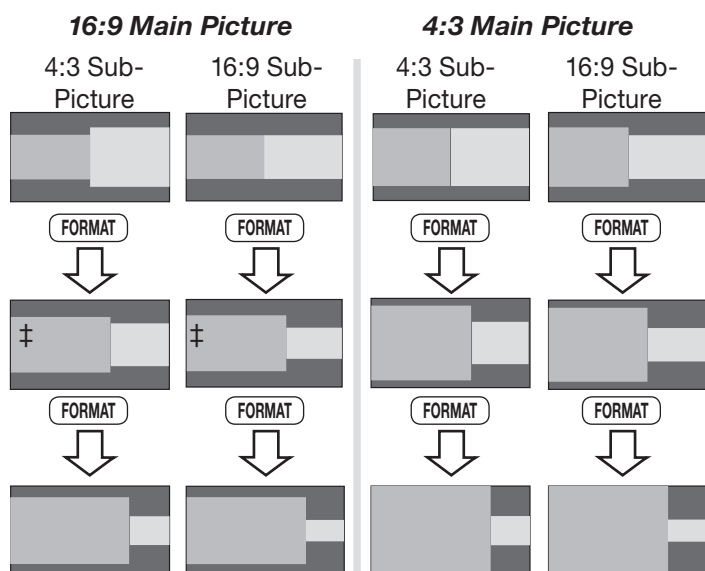

Press the **FORMAT** key repeatedly while in Split Screen mode to change the display.

‡ **HDMI 1080p** can appear only as main picture in the marked Split Screen combinations.

TV Inputs for Split Screen

The available Split Screen picture sources are listed below. Check marks indicate combinations of picture sources you can view in Split Screen mode.

Main Picture	Sub-Picture	ANT 1	ANT 2	INPUT	COMPONENT	HDMI	HDMI (1080p)	IEEE 1394
ANT 1				✓	✓	✓		✓
ANT 2				✓	✓	✓		✓
INPUT		✓	✓	✓*	✓	✓		✓
COMPONENT		✓	✓	✓	✓**	✓		✓
HDMI		✓	✓	✓	✓			✓
IEEE 1394		✓	✓	✓	✓	✓		

* Only when main picture and sub-picture are from different **INPUT** jacks.

** Only when main picture and sub-picture are from different **COMPONENT** jacks.

Viewing Camera Files

JPEG Photos and the USB Photo Port

1. Connect your digital camera or USB drive to the USB Photo port on the front of the TV. If using a camera, power it on and set it to playback mode.

The **USB Photo** menu displays while files are still being read. Wait until you see the completion message on screen before continuing.

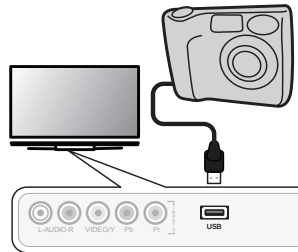

Note: Some manufacturers' devices may be incompatible with the TV. If the TV is unable to display your photos, you can:

- Try transferring files to a different USB device.
- Use the camera's composite video output as described later in this chapter.

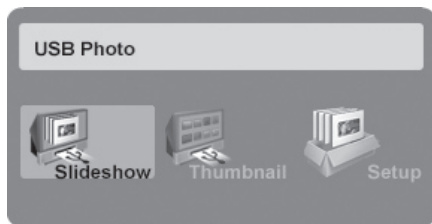

USB Photo menu

2. After files have been read, you can do the following from the **USB Photo** menu:

USB Photo Menu Options

Start slide show.	With the Slideshow icon highlighted, press ▶ or ENTER .
Activate menu options.	Highlight an icon and press ENTER to: <ul style="list-style-type: none"> • start the slide show • display picture thumbnails • open the Media Setup submenu.
Display or close the Main menu.	Press MENU .
Display status for the file source.	Press INFO .
Select a different connected device	<ol style="list-style-type: none"> 1. Press INPUT. 2. Highlight the icon for a different device. 3. Press ENTER.
Clear status display or menu to show the USB Photo menu	Press EXIT .



JPEG Thumbnail Menu

Use these keys while viewing JPEG thumbnail images:

Keys for the JPEG Thumbnail Menu

▲ ▼ ◀ ▶	Move the highlight from image to image.
FORMAT	Rotate the thumbnail clockwise in 90° increments
▶ or ENTER	Play the slide show starting with the highlighted thumbnail.
▶▶	Highlight the last thumbnail on the current page.
◀◀	Highlight the first thumbnail on the current page.
CH/PAGE ▲/▼	Display the next or previous page of thumbnails.
EXIT	Close the Thumbnail menu and display the USB Photo menu.
MENU	Close the Thumbnail menu and display the Main menu.
INPUT	Close the Thumbnail menu and display the Input Selection menu.

Notes on Viewing JPEG Files

- The TV ignores all commands while reading files. Wait for the completion message before continuing.
- Large files or high-capacity storage devices may take a long time to display. The screen will be blank while files are read.
- Use only one source device at a time.





IMPORTANT

Stop playback or change to a different TV input before disconnecting from the USB photo port.

Slide Show

Use these keys during the slide show:

Keys for JPEG Picture Slide Show

	Begin or resume slide show playback
	Pause or resume playback while in automatic advance mode.
 or ENTER	Advance to the next slide.
	Go to the previous slide.
FORMAT	Rotate the slide clockwise in 90° increments.
	Stop slide show and display the USB Photo menu.
INFO	Display status for the viewing device and current image.
INPUT	Display the Input Selection menu.
MENU	Display or remove the TV Main menu.

Note: Always press  (STOP) to stop slide show playback before disconnecting from the USB Photo port.

Media Setup Menu

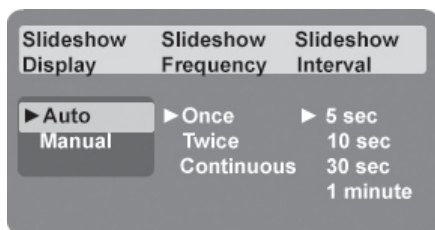

Media Setup menu

In the **Media Setup** menu you can adjust the slide show display, number of repetitions, or display interval.

- Select either **Auto** or **Manual** advance. During manual operation, press  or ENTER to advance to the next slide.
- For automatic advance, select the number of times (frequency) to play the complete slide show: **Once**, **Twice**, or **Continuous**.
- For automatic advance, select the time interval for display of each slide. The interval you select here is the minimum time between slides; actual time may be longer for larger files.
- Press EXIT to close the **Media Setup** menu and return to the **USB Photo** menu.

IMPORTANT

The TV can read JPEG files as created by the camera. If you edit a picture file on a computer and resave the image, the TV may be unable to read the resaved file.

USB Photo Menu Compatible Picture Files

- Still images recorded on digital cameras using the Exchangeable Image File Format, version 2.1 (EXIF 2.1) standard for digital still cameras and Design Rules for Camera File Systems version 1.0 (DCF 1.0)
- Some images opened and resaved on a computer may not play back or may not display in the thumbnail list. This happens if the files were resaved in an incompatible format.
- Full path file names can be no longer than 50 characters and must end in a .jpg extension. Only the first 20 of the 50 characters will display.
- Images on storage devices with a capacity of over 256 MB can take a longer initial time to display.

Photos and Moving Video as Composite Video

Connect the camera to the TV using a composite video cable if:

- You are unable to see images using the USB photo port.
- You wish to view moving video from the camera.

The TV's **USB Photo** menu will be unavailable and you must control the slide show through the camera. Display resolution is standard-definition (480i).

1. Refer to the owner's manual supplied with the camera for instructions needed for this setup.
2. Set the camera's output signal type to **NTSC** and put the camera into playback mode.
3. With the camera still turned on, connect your digital camera's composite video cable (usually yellow) to the **INPUT 3 VIDEO/Y** jack on the front of the TV. To hear audio, connect the camera's audio output cable to the **INPUT 3 L-AUDIO** jack.
4. When the **Auto Input Sensing** screen displays, press EXIT or assign the name **Camcorder**.
5. Press INPUT to display the **Input Selection** menu.
6. Highlight the icon for the camera input and press ENTER.
7. If viewing photos, advance through the images manually or set the camera to advance automatically.

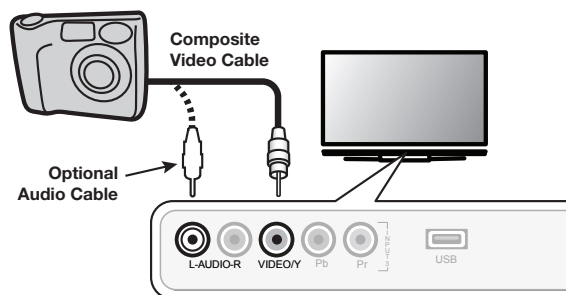







Camera connection using a composite video cable

5 TV Menu Settings

Main Menu

Press **MENU** on the remote control to open the **Main** menu.

Icon	Menu Name and Description
	Record Menu Set up or cancel NetCommand-controlled recordings. See chapter 6, "NetCommand."
	AV Menu Customize picture and sound settings.
	Captions Menu Turn closed captions on and off; customize caption displays.
	Setup Menu Perform basic TV setup. Set language, scan (memorize) channels, set the TV clock, edit channel options, lock TV use by channel, set Energy Mode, Lamp Mode, auto-on TV Timer.
	Inputs Menu Assign names to TV inputs, change icon order in the Input Selection menu, perform NetCommand IR "learning," set up TV Guide On Screen.
	Lock Menu Restrict TV use by program ratings and by time of day. Disable the front-panel control buttons. Set a pass code.

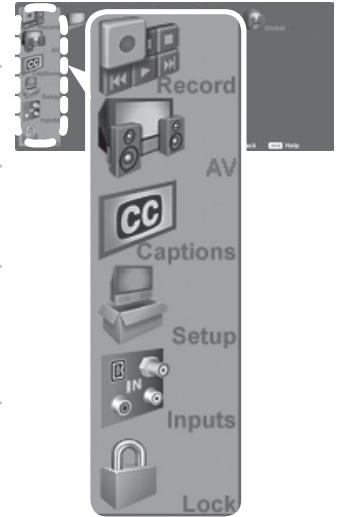

Main menu

Remote Control Keys for the TV Menu System

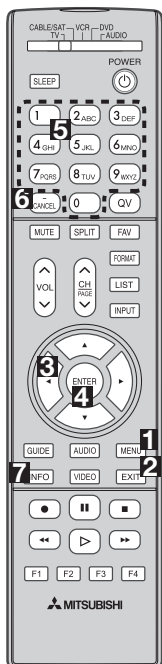

Key	Function
1 MENU	Display or close the Main menu or move back one menu level.
2 EXIT	Close all menus and return to TV viewing.
3 (Adjust Left/Right Keys) (Adjust Up/Down Keys)	<ul style="list-style-type: none"> • Move through screens to select menu options. • Change settings. • Scroll through lists.
4 ENTER	Start an automatic function or check/uncheck select a check box. When setting time, move from hour digits to minutes digits and from month to day to year digits.
5 Numbers Letters	Enter channel numbers. Enter your ZIP code for the TV Guide On Screen system. Enter custom names in some text boxes.
6 CANCEL	<ul style="list-style-type: none"> • Clear a setting or stop an automatic function. • Add a separator in a digital channel number.
7 INFO	Get context-sensitive help.







AV Menu

An on-screen slider displays when making some audio and video adjustments. Numeric values represented on the slider range from 0 (minimum) to 63 (maximum), with 31 as the mid-point.



AV menu for audio and video adjustments

AV Menu Options

 Video	See the description of video adjustments later in this section.	
 Audio	See the description of audio adjustments later in this section.	
 Reset	<ul style="list-style-type: none"> To reset audio and video adjustments for the current input, highlight the Reset icon and press ENTER. Reset has no effect on settings for Balance, Listen To, Language, and Film Mode. 	
 PerfectColor	PerfectColor Sliders	Adjust the saturation (intensity) of six colors for the current image source.
	PerfectTint Sliders	Adjust six hues for the current image source
	<p>Highlight the PerfectColor™ icon and press ENTER to display the PerfectColor menu. Settings are retained in memory independently for each TV input.</p> <ul style="list-style-type: none"> To switch between PerfectColor™ and PerfectTint™ adjustments, highlight Adjust Mode and press ◀ ▶. Press ▲ ▼ to move from one color bar to the next. Press ◀ ▶ to change settings. Press CANCEL to restore default settings. Press MENU to return to the Main menu. 	





AV Menu, continued



AV > FX Gaming menu for game adjustments

AV Menu Options

 Global	Video Noise	High, Medium, Low, Off	Reduce minor noise (graininess) in the picture. Use Low with good-quality signals. Use High with poor-quality signals. Use Off to leave the picture unaltered. Saved by input.
	Video Mute	On, Off	On displays a blue background when no signal is being received on the current INPUT, COMPONENT, or HDMI jack.
	Film Mode (480i and 1080i signals only)	Auto, Off	In Auto , the TV automatically detects and applies film-decoding correction. Try the Off setting if images show too many jagged edges. Saved by input.
	SharpEdge	On, Off	Use SharpEdge™ to add special edge enhancements to make the image appear sharper. Saved by input.
	Smooth 120 Hz	On, Off	When On , Smooth120Hz™ reduces motion blur in action scenes but may show pixel structure during slower motion or in still images. When Off , standard picture smoothing processing is employed.
	Blue Glow	On if TV off, On if TV on, Off	Select one of the On settings to see decorative blue lighting on the TV.
 FX Gaming	Game Mode	Off, On	Use the On setting for video gaming with 3-D glasses.
	Glasses L-R	Standard, Reverse	Synchronize left view with left glasses to provide the best image. Standard is the default; try Reverse if this seems incorrect.

Note: Game options are available when the selected input is named **PC** or **Game** and is connected to an HDMI input. Expanded future gaming features include FX gaming options. See www.mitsubishi-tv.com for details.

Video Menu

Mitsubishi recommends you assign names to TV inputs before making video adjustments (use the **Inputs > Name** menu). Otherwise, adjustments will be reset to the defaults if you name inputs afterwards.

To make video adjustments:

- **From the Video menu:**
 1. Press ▲ ▼ to highlight an option.
 2. Press ◀ ▶ to display the submenu and adjust.
 3. Press MENU to return to the AV menu.
- **While watching TV:** Press the VIDEO key repeatedly to display the video option you want to change. Press ◀ ▶ to change settings.

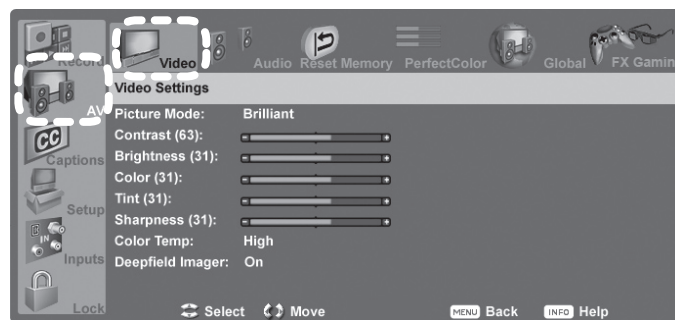

AV menu, Video options

Note: See chapter 2, “TV Setup,” for additional adjustments available for images from a computer.

Video Menu Options

Picture Mode	Brilliant	For use under strong light	Set the Picture Mode first before changing other video settings, as some are stored independently for each Picture Mode. Use Picture Modes to optimize the image for different conditions.
	Game	Optimize picture and video processing for gaming consoles. Available only when the name of the input is Game or PC .	
	Bright	For most daytime viewing and x.v.Color sources	
	Natural	For most nighttime viewing and x.v.Color sources	
Contrast	<ul style="list-style-type: none"> • Adjust the white-to-black level • Low contrast shows a variety of shades in darker images • In most home lighting situations, medium contrast looks best. • High contrast shows darker images more uniformly black and makes colors appear more vibrant. High contrast is good for brightly lit environments. • Settings are stored independently for each Picture Mode. 		
Brightness	<ul style="list-style-type: none"> • Adjust overall picture brightness • Settings are stored independently for each Picture Mode. 		
Color	Adjust overall color intensity		
Tint	Adjust the red-to-green ratio.		
Sharpness	Adjust picture detail and clarity.		
Color Temp	Adjust the white balance. Settings are stored independently for each Picture Mode.		
	High	Give white images a cool cast. May provide the most realistic picture under bright lighting.	
	Low	Give white images a warm cast. Natural/Color Temp at the low setting displays video at approximately the 6500K industry standard for NTSC pictures.	
Deep Field Imager	On	With DeepField™ Imager On , black levels are dynamically enhanced in portions of the screen to provide strong contrast with detail over mixed screen content.	
	Off	Contrast is adjusted uniformly across the entire screen.	
	Demo	Display a split picture to show on (right side) or off (left side).	

Audio Menu

To make audio adjustments:

- **From the Audio menu:**
 1. Press ▲▼ to highlight an option
 2. Press ◀▶ to display the submenu and adjust.
 3. Press MENU to return to the **AV** menu.
- **While watching TV:** Press the **AUDIO** key repeatedly to display the audio option you want to change. Press ◀▶ to change settings.



AV menu, Audio options

Audio Menu Options		
Speakers	The Speakers option displays only if an A/V receiver connection has been detected.	
	TV	Turn on the internal TV speakers.
	AV Receiver	Turn off the TV speakers and hear sound only from a connected A/V receiver.
Bass	Control volume level of low-pitched sound from the TV speakers.	
Treble	Control volume level of high-pitched sound from the TV speakers.	
Balance	Control audio balance between the right and left TV speakers	
Surround	Off	No surround effects from the TV speakers (default)
	Simulated Stereo	Create a simulated stereo effect through the TV speakers when watching a monaural (non-stereo) program.
	Surround Sound	Create a simulated surround effect through the TV speakers when watching a stereo program.
Listen To (analog channels from ANT1/ANT2 only)	Stereo	Default setting. The TV plays stereo broadcasts in stereo and mono broadcasts in mono. The word Stereo is displayed when you tune to a channel broadcasting in stereo.
	SAP (Second Audio Program)	Select an additional monaural sound track not audible during normal TV viewing. The SAP signal might be related to the program (such as a sound track in a foreign language), or it might be unrelated (such as a weather report). If an SAP signal is broadcast, the letters SAP are displayed when you tune to the channel
	Mono	Reduce background noise. Use when receiving a weak stereo audio signal. All audio is played as mono with this setting.
Language (digital channels from ANT1/ANT2 only)	English French German Italian Portuguese Spanish Other	Select the current language for a digital program from an ANT input. Each digital program may include up to seven language choices or no choice at all.
Level Sound	On, Off	Reduce differences in sound volume between programming segments, such as the difference between regular broadcast programs and commercial segments.



Captions Menu

Captions on Analog Channels

The TV can decode captions from **ANT 1/ANT 2** and the **INPUT 1–3** jacks. Broadcasters can send either standard closed captions or text service. Standard closed captions follow the dialogue of the program and display in a small section of the screen. Text-service closed captions often contain information such as weather or news and cover a large portion of the screen.

IMPORTANT

- **Analog text-service options display a large black or gray box on the screen when no signal is being broadcast.**
- **The content of captions is determined by the broadcaster. If captions show strange characters, misspellings, or odd grammar, it is not a malfunction of the TV.**
- **Closed caption signals are not available through HDMI or component jacks. See the menus for these devices for closed-caption decoding.**

Captions on Digital Channels

The TV can decode captions from **ANT 1/ANT 2** and IEEE 1394 devices only. Broadcasters can send up to six different captioning selections or can send analog captions that match those sent by the analog station. A TV station may broadcast only one or two types of captions or none at all.

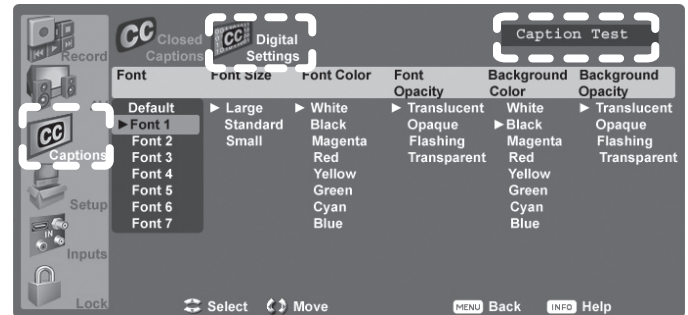

Digital Settings menu. Check the caption test area (upper right) to see how custom settings look.

Captions Menu Options

 Closed Captions	Analog Captions	On if Mute CC 1–CC 4 Text 1–Text 4 Off	<ul style="list-style-type: none"> • On if Mute: Display analog closed captions signal CC 1 when audio from the TV speakers is muted. When watching TV, press MUTE to turn captions on/off. • CC 1–CC 4: Standard closed-caption signals • Text 1–Text 4: Text-service signals
	Analog Background	Gray, Black	Select either a gray or black text background to make analog closed captions easier to read.
	Digital Captions	On if Mute Caption 1–Caption 6 Off	<ul style="list-style-type: none"> • On if Mute: Display digital closed caption signal Caption 1 when audio from the TV speakers is muted. When watching TV, press MUTE to turn closed captions on/off. • Caption 1–Caption 6: Caption signals sent by the broadcaster
 Digital Settings	Font	Default Font 1–Font 7	Default changes settings to those selected by the captions provider, or, if none, to the TV’s own captions defaults. Use Fonts 1 through 7 to give captions a custom appearance.
	Font Size	Large Standard Small	Large is the recommended size.
	Font Color	White, Black, Magenta, etc.	Guidelines for setting digital captions: <ul style="list-style-type: none"> • Use contrasting colors for captions and background. • Check readability of captions using the sample text in the upper right corner of the menu. • A white font on a black translucent background makes an easy-to-read combination.
	Font Opacity	Translucent, Opaque, Flashing, Transparent	
	Background Color	White, Black, Magenta, etc.	
Background Opacity	Translucent, Opaque, Flashing, Transparent		



Setup Menu

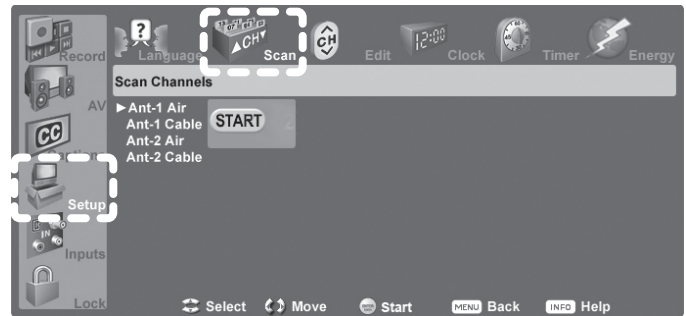

Use the **Setup** menu to:

- Select English or Spanish for menus and on-screen text.
- Scan the channels available for the antenna or cable service connected to the **ANT 1** or **ANT 2** jacks.
- Edit channel options, including channel locking.
- Set the TV's internal clock.
- Set the TV Timer to turn on the TV automatically at a designated time.
- Set the energy mode for power consumption when the TV is powered off.
- Set the TV Lamp Mode.



Setup menu, Scan option

Setup Menu Options

 Language	English Spanish	Display on-screen menus in either English or Spanish. Note: To listen to audio in other languages (when available), see the section on the AV menu, Audio submenu, and refer to either Listen To > SAP (analog signal) or Language (digital signal).
 Scan	Ant-1 Air Ant-1 Cable Ant-2 Air Ant-2 Cable	Scan memorizes broadcast channels to make them easier to find. To start channel memorization: <ol style="list-style-type: none"> 1. Highlight one of the input selections based on your connection to ANT 1 or ANT 2: <ul style="list-style-type: none"> • Air when connected to an indoor or outdoor antenna. • Cable when connected to direct cable (no cable box) 2. Press ▶ to highlight START. 3. Press ENTER to start channel memorization for the selected input.

Notes on Scan and channel memorization:

- Channel memorization may take up to 15 minutes to complete.
- To stop channel memorization before completion, press **CANCEL**.
- When watching TV, press **CH ▲ ▼** to move through memorized channels.
- If you restart memorization, previously memorized channels for the selected input will be erased.
- To add a digital channel that does not appear in the **Edit** menu without repeating channel memorization:
 1. Look up the physical channel number for the new digital channel. The website www.antennaweb.org can help you find the physical channel number.
 2. Tune to any channel on the **ANT 1** or **ANT 2** input your antenna is connected to.
 3. Use the number keys and **CANCEL** to enter the physical channel number followed by “-1” and **ENTER**. For example, for physical channel 36, press **3 6 CANCEL 1 ENTER**.

The TV will search for a digital channel on the channel 36 frequency. When it finds the channel, it will:

 - a. Add the channel to memory.
 - b. Change the channel number to the virtual channel number sent by the broadcaster.
 - c. Add to memory any associated sub-channels.
- In the TV Guide On Screen system, the channels displayed and the order in which they are displayed are independent of the TV's channel memorization performed with **Scan**. Refer to the *TV Guide On Screen Interactive Program Guide User's Manual* for detailed instructions on editing channels in the TV Guide On Screen system.



Setup Menu, continued

Edit

Virtual Channel Number (digital channels only). A channel number sent by a local broadcaster. Usually the virtual number is associated with the corresponding analog channel number. For example, a broadcaster may associate digital channel 2-1 with their analog channel 2.

Physical Digital Channel Number. The channel number officially assigned to the actual broadcast frequency; shown on screen in parentheses.



Setup menu, Edit channel options

Setup Menu Options



Edit

Use the **Edit** menu to edit channel options when **ANT 1** or **ANT 2** is the current source. To highlight a channel number to edit:

- Press **CH** \wedge/\vee to jump to the next page of channel numbers. Press and hold **CH** \wedge/\vee to speed through pages.
- Press $\blacktriangle/\blacktriangledown$ to move through all channel numbers, one at a time. Press and hold $\blacktriangle/\blacktriangledown$ to speed through channel numbers.

The TV tunes to the highlighted channel on release of **CH** \wedge/\vee or $\blacktriangle/\blacktriangledown$.

Channel Channels marked with a check are in memory. To add or delete a channel from memory, highlight the channel number and press **ENTER**. To add a single digital channel not in the list, see the notes under **Scan**.
Digital channels are listed by virtual channel number with the physical channel number shown in parentheses.

Name Assign a custom name up to six characters long to memorized channels. You can name analog channels and digital channels if broadcast without pre-assigned names.

1. With the cursor in the **Name** field, press a number key repeatedly to cycle through the characters associated with the key, including !, &, blank (1 key) and /, *, - (0 key).
2. Press **ENTER** to set the letter and move to the next letter position. To delete the current character and move back one position, press **CANCEL**.

Note: When the TV Guide On Screen system is enabled, the name displayed is the name provided by TV Guide On Screen instead of the name you assign here.

Fav1–Fav6 Use the six Fav channel banks to store groups of your favorite channels. For example, you can set up a Fav channel bank for each of your favorite program types (e.g., sports, news, children's programs) or set up a bank for each TV user.

- Use $\blacktriangle/\blacktriangledown/\blacktriangleleft/\blacktriangleright$ to move the highlight through the **Fav** area of the screen.
- Press **ENTER** to insert a check mark to add the highlighted channel to one of the Fav banks.
- The same channel can be added to multiple Fav banks
- To remove a channel from a Fav bank, highlight the check mark and press **ENTER**.

Note: To set up Fav channel banks without using this menu, see chapter 4, "TV Operation and Features."

Lock Lock channels so that a pass code is required to view them. When you rememorize channels, all lock settings are cleared.
Highlight the **Lock** column and enter a pass code when prompted. If you previously set a pass code to open the main **Lock** menu, use the same pass code. See the description of the **Main** menu > **Lock** for more on pass codes.

- Press **ENTER** to insert a check mark to lock the highlighted channel.
- To unlock a channel, highlight the check mark and press **ENTER**.



Setup Menu, continued

Clock

Use either the manual or auto method to set the clock. Set the clock if you wish to:

- Use the TV's Timer function.
- Maintain accurate ChannelView listings.
- Schedule NetCommand- and TV Guide On Screen-controlled recordings.

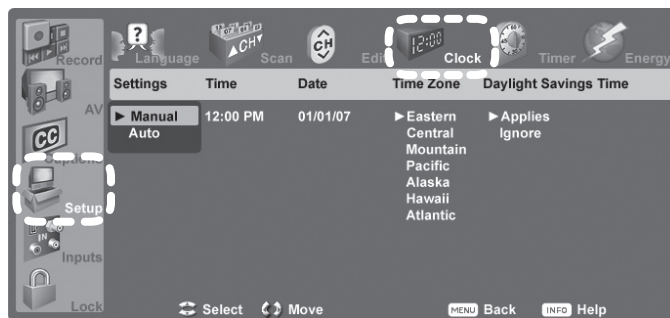

Setup menu, Clock options

Setup Menu Options



Clock

Settings

Manual. To set the clock manually:

1. Select **Manual**.
2. Set the time of day.
3. Set the date.
4. Select your time zone.
5. Select either **Applies** or **Ignore** for **Daylight Savings Time**.

Note: If using **Manual**, each time the time change occurs, you must open this menu and set the TV's clock ahead or back.

Auto. To set the clock automatically:

1. Select **Auto**.
2. Select your time zone.
3. Select either **Applies** or **Ignore** for Daylight Savings Time.
4. After exiting the menus, tune the TV to a station carrying XDS data, typically a PBS station.

Note:

- With the **Auto** setting, the TV's clock adjusts automatically to daylight savings time.
- The TV's clock will be reset if you tune to a channel sending incorrect time data. To prevent unwanted clock resets, first use the **Auto** method to set the clock from a channel sending the correct time, then change the method to **Manual**.

Time (Manual option only)

1. With the hour highlighted, press ▲ ▼ repeatedly to change the hour and the **AM/PM** indicator. Press and hold to change the hour display quickly.
2. Press **ENTER** to set the hour.
3. With the minutes highlighted, press ▲ ▼ to change the minutes. Press and hold to change the minutes display quickly.

Date (Manual option only)

1. With the month highlighted, press ▲ ▼ to select. Press **ENTER** to set.
2. With the day highlighted, press ▲ ▼ to select. Press **ENTER** to set.
3. With the year highlighted, press ▲ ▼ to select the current year.

Time Zone

Eastern, Central, Mountain, Pacific, etc. Required for both the **Manual** and **Auto** methods.

Daylight Savings Time

Applies Ignore Required for both the **Manual** and **Auto** methods. Select the option for your area.



Setup Menu, continued

Timer

Use the Timer to set a time for the TV to turn on automatically. Use this menu to set a day, time, input, and channel for the Timer. If the TV is already on at the requested time, the TV will automatically tune to the designated channel.

- The TV clock must be set before you can use the Timer feature.
- When the Timer turns on the TV, press any key on the remote control to keep it on. Otherwise, the TV will turn off after five minutes.
- The **TIMER** indicator slowly flashes green when the TV is off to indicate the TV Timer has been set.

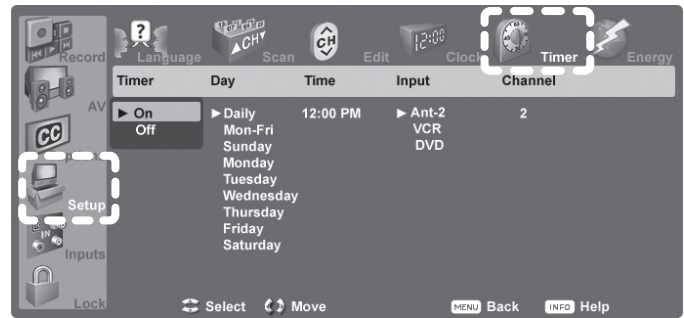

Setup menu, Timer options

Setup Menu Options

 Timer	Timer	On, Off
	Day	Daily, Mon-Fri, (every) Sunday, (every) Monday, (every) Tuesday, etc. Select the day or days of the week for the Timer to turn on the TV.
	Time	To set the time for the TV to come on: 1. With the hour highlighted, press ▲▼ repeatedly to change the hour and the AM/PM indicator. Press and hold to change the hour display quickly. 2. Press ENTER to highlight the minutes. 3. Press ▲▼ to change the minutes. Press and hold to change the minutes display quickly.
	Input	Ant-1, Ant-2, DVD, VCR, etc. Select the input you want displayed when the TV comes on. Choose from the defined and enabled inputs that appear in the Input Selection menu.
	Channel	If the input is an antenna (ANT 1, ANT 2), press ▲▼ repeatedly or press and hold to scroll quickly through the available channel numbers.



Setup Menu, continued

Energy

The Energy options give you ways to reduce TV power consumption.



Setup menu, Energy options

Setup Menu Options



Energy

Energy Mode	Fast Power On	Use the Energy Mode option to select the level of power consumption while the TV is turned off. The default setting is Fast Power On .
	Low Power	Low Power uses less energy, but TV power-on takes longer and some TV features may be unavailable.

Keep Energy Mode set to **Fast Power On** if you need to:

- Have faster power on.
- Receive updates to ChannelView channel listings.
- Receive updates to the TV Guide On Screen program listings.
- Keep the TV Clock accurate for the TV Timer and for scheduling NetCommand-controlled recordings. With the **Low Power** setting, you must reset the TV Clock if the TV is left turned off for over 48 hours.
- Leave the TV off while making a NetCommand-controlled recording.
- Schedule future NetCommand-controlled recordings for a time when the TV will be off.

Note: TV Guide On Screen requires the **Fast Power On** setting. If you activate TV Guide On Screen, the TV will automatically override a **Low Power** setting and change to the **Fast Power On** setting.

Lamp Mode	Standard	Standard is for most viewing conditions and may extend lamp life by using lower wattage. Use Bright in brightly lit rooms.
	Bright	



Inputs Menu

Note:



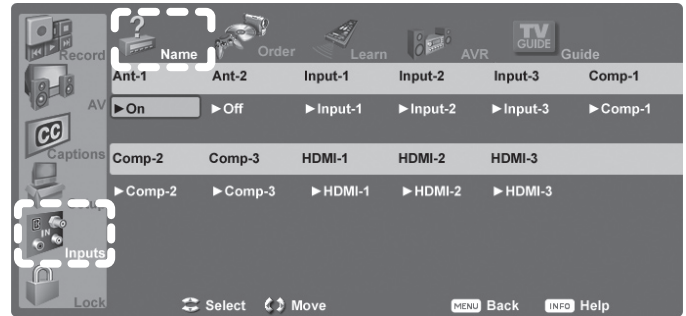

When you change an input name in the **Name** menu and then exit the **Name** menu:

- The name is changed
- The icon in the **Input Selection** menu is changed
- Audio and video settings are changed to the defaults for the new device type.
- All NetCommand “learning” for the input is also erased.



Change input names using the Inputs > Name menu.

Inputs Menu Options

 <p>Name</p>	<p>Cable Box, Camcorder, DVD, DVD2, DVR, Game, HD Disc, Satellite, VCR, PC</p> <p>On/Off (ANT 1 and 2 only)</p> <p>Off (HDMI only)</p>	<ul style="list-style-type: none"> • Assign or change names of inputs appearing in the Input Selection menu. • Turn Ant-1 and Ant-2 On or Off. • Turn unused HDMI inputs Off. • Press ◀ ▶ to move between inputs. • Press ▲ ▼ to select a name. • If you change the name of an input after performing NetCommand “learning,” the IR codes you “learned” are erased. <p>Note: When you disconnect an HDMI device, the icon remains in the Input Selection menu until you remove it. To remove an unwanted HDMI icon, select Off for the HDMI input.</p>	
 <p>Order</p>	<p>Put frequently used icons at the start of the Input Selection menu.</p> <ol style="list-style-type: none"> 1. Press ▲ ▼ ◀ ▶ to highlight the icon to move. 2. Press ENTER to confirm the selection. 3. Press ▲ ▼ ◀ ▶ to drag the icon to the desired position. 4. Press ENTER to set the new position. 		
 <p>Learn</p>	<ul style="list-style-type: none"> • Perform initial set-up of NetCommand control of a device. • Add or remove individual keys from NetCommand control of a device. <p>See detailed instructions in chapter 6, “NetCommand.”</p>		
 <p>AVR</p>	<p>Set up NetCommand control of an A/V receiver. This set-up allows you to:</p> <ul style="list-style-type: none"> • Operate the A/V receiver’s power and volume functions with the TV’s remote control. • Make the A/V receiver switch automatically to the correct audio input when you select a device in the TV’s Input Selection menu. <p>See detailed instructions in chapter 6, “NetCommand.”</p>		
 <p>Guide</p>	<p>Guide</p>	<p>On/Off</p>	<p>See instructions on the following page for the TV Guide On Screen system.</p>
	<p>Devices</p>	<p>Ant-1, Ant-2</p>	
	<p>Zip Code</p>	<p>[5-digit ZIP code]</p>	



Inputs Menu

Setting Up TV Guide On Screen

Setup of the TV Guide On Screen system is optional.

- You must set up NetCommand control of a VCR or A/V disc for recording if you wish to enable recordings through TV Guide On Screen.
- Many features of TV Guide On Screen are available without NetCommand control. For example, program listings, program searches, and program reminders function without NetCommand.

1. Display the **Inputs > Guide** menu to display TV Guide On Screen setup options.
2. To enable the TV Guide On Screen system, highlight **On**. If you wish to disable the system, highlight **Off**.

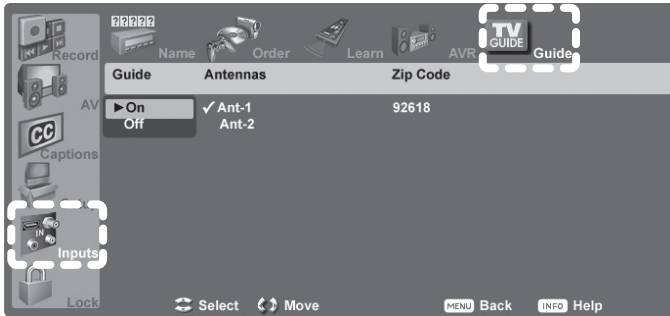

Inputs > Guide menu for TV Guide On Screen setup

3. Select program sources for the listings. You can select one over-the-air source or one direct-cable

IMPORTANT

- After setup, it may take up to 24 hours to start receiving program listings and then it may take up to one week to receive all eight days of listings.
- Leave the TV powered off for a while each day to allow new listings to download.

source for TV Guide On Screen. If, however, you have multiple cable sources, the channel-number assignments may not match up correctly. See the following table and notes for the preferred connection combinations.

If One Source Is:	The Other Source Can Be:	
	Ant-1 Air	Ant-2 Air
Ant-1 Channels via Cable	N/A	✓
Ant-2 Channels via Cable	✓	N/A

Note:

- Inputs to TV Guide On Screen can include only one over-the-air source or only one direct-cable source.
 - TV Guide On Screen listings can be downloaded from an over-the-air antenna or direct cable connected to **ANT 1** or **ANT 2**.
4. Highlight the **ZIP Code** digits and enter the five-digit ZIP code for your location. To receive the correct program listings for your area, you must enter the ZIP code.

Using the TV Guide On Screen System

- With the Guide set up and enabled, use the **GUIDE** key on the remote control to launch the TV Guide On Screen system.
- For detailed information, see the separate *TV Guide On Screen Interactive Program Guide User's Manual* included with the TV.



Lock Menu

TV locks available from the **Lock** menu are:

	Parent	Lock by Ratings Restrict access to programming based on V-Chip rating signals sent by the broadcaster.
	Other	
	Time	Lock by Time Restrict TV use by time of day.
	Front Panel	Lock Front Panel Disable the controls on the front of the TV. Use this option if small children in the home try to press front-panel buttons.

Note: **Channel Lock** is an additional lock that blocks access to specific channels. Channel Lock is available under the **Setup** menu (**Setup** > **Edit** > **Lock**).

Pass Codes

Setting a Pass Code

You are prompted to enter a pass code whenever you select **Lock** on the **Main** menu. To set a pass code for the first time:

- Press **MENU**, highlight **Lock**, then press **►**. A screen prompting you for a pass code will display.
- Input a four-digit pass code using the number keys on the remote control.
 - Press **CANCEL** to delete a number and move back one space.
 - Press **MENU** or **EXIT** to close the menu without setting a pass code.
- Press **ENTER** to set the pass code.

Resetting a Pass Code

See the procedure in Appendix C.

Important Notes on Rating Locks

- Parent** menu rating locks apply only to channels and signals received on **ANT 1**, **ANT 2**, the **INPUT 1–3** jacks, and from an IEEE 1394 A/V disc.
- Other** menu rating locks apply only to digital channels received on **ANT 1** or **ANT 2** and A/V discs.
- When viewing a cable box, satellite receiver, or other device connected to the **COMPONENT** or **HDMI** inputs, check the device's menu for rating locks.

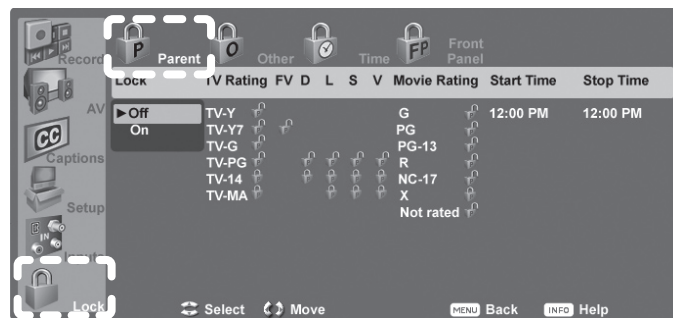

The **Lock** > **Parent** menu lets you set parental controls using V-Chip technology.

Parent Menu

The TV comes from the factory with the rating locks turned off and with pre-set U.S. ratings TV-PG and movie rating PG. Turn on blocking for U.S. ratings to activate these rating restrictions. Use the **Lock** > **Parent** menu to change the level of blocking with U.S. ratings.

Any time you change the channel or device, it may take up to five seconds for the rating restrictions to take effect.

Other Menu (Alternate Rating System)

This TV can recognize new rating systems that may come into effect in the future. The **Other** menu allows you to block digital programming when such systems come into effect.

The first time you tune to a channel broadcasting an alternate rating system, the TV defaults to the most restrictive setting if the **Lock** menu > **Other Lock** option is set to **On**. Use this menu to change the allowed rating if you are unable to watch a program broadcast with an alternate system.

Bypassing TV Locks

If you try to watch a blocked program or channel or try to use the TV while it is locked by time, a notice appears prompting you for a pass code. To use the TV:

- Input your four-digit pass code and press **ENTER**.
- Change to a channel airing an allowed program or change to another device.

To reactivate the parent ratings lock or TV Lock by Time after using the pass code:

- Power the TV off and then on to reactivate both locks.
- Change to a different channel or device to reactivate only the parent ratings lock.

**Lock Menu, continued****Parent Menu Options (U.S.-based rating system)**

Option Name and Description		
Lock	Off, On	Disables or enables program blocking based on V-Chip signals and the U.S. rating system.
TV Rating	TV-Y	Youth. For children under 7.
	TV-Y7	Youth 7 and older.
	TV-G	General Audience. For the entire family.
	TV-PG	Parental Guidance. Parental Guidance recommended; may not be suitable for some children.
	TV-14	Adolescent 14 and older. Not recommended for children under 14.
	TV-MA	Mature Audience. For adults only.
FV	Fantasy Violence. Applies to TV-Y7 only.	
D	Sexual Dialog. Applies in differing degrees to TV-PG and TV-14.	
L	Adult Language. Applies in differing degrees to TV-PG, TV-14, and TV-MA.	
S	Sexual Situations. Applies in differing degrees to TV-PG, TV-14, and TV-MA.	
V	Violence (graphic or realistic). Applies in differing degrees to TV-PG, TV-14, and TV-MA.	
Movie Rating	G	General Audience. Designed for the entire family to view.
	PG	Parental Guidance. Parental Guidance is recommended, may not be suitable for some children.
	PG-13	Parental Guidance, 13 and Older. Not recommended for children under the age of 13.
	R	Restricted. Restricted in theaters to 17 years old and older unless accompanied by an adult.
	NC-17	No Children 17 or Under. Restricted in theaters to 18 years old and older.
	X	Adult. Designed for and restricted in theaters to adult audiences only.
	Not Rated	The program has not been assigned an MPAA rating.
Start Time	Allows you to set the time of day for enforcement of rating restrictions set in the Parent menu.	
Stop Time	1. Highlight the hour digits for Start Time .	
	2. Press ▲ ▼ repeatedly to change the hour and associated AM/PM indicator. You can also just press and hold to move quickly through the numbers.	
	3. Press ENTER to highlight the minutes.	
	4. With the minutes digits highlighted, press ▲ ▼ repeatedly to change the minutes. You can also just press and hold to move quickly through the numbers.	
	5. Highlight the Stop Time digits and set the time as described above.	
Note: To make rating restrictions active 24 hours a day, make Start Time and Stop Time the same.		

Highlight the rating level you wish to change and press **ENTER** to block it (🔒) or allow it (🔓).

You can apply supplemental content blocking to the age-based ratings by using the TV content categories listed below.

TV Content Categories



Lock Menu, continued



Other Menu Options (alternate rating system)

This TV can recognize new rating systems that may come into effect in the future. The **Other** option remains grayed out until the TV receives a signal using an alternate rating system. Such alternate rating systems will apply to digital programming only.

Option Name and Description	
Lock	On, Off Enable or disable program blocking.
System Name	The rating system available for the channel
Group	Rating groups available in the rating system shown on the screen. Rating groups are defined by the rating system in effect.
Rating	Rating restrictions available in the selected rating system and group. Highlight the rating and press ENTER to check (block) or uncheck (allow) rated content.



Time

Block all use of the TV during the time period you specify. You must enter a pass code to use the TV when the time lock is in effect.

Lock by Time	On, Off Enable or disable Lock by Time.
Lock Time, Unlock Time	<p>To set the lock and unlock times:</p> <ol style="list-style-type: none"> 1. Highlight the hour digits for the Lock Time. 2. Press ▲▼ repeatedly to change the hour and associated AM/PM indicator. To move quickly through the numbers, just press and hold. 3. Press ENTER to set the hour and highlight the minutes. 4. With the minutes highlighted, press ▲▼ repeatedly to change the minutes. To move quickly through the numbers, just press and hold. 5. Highlight the Unlock Time digits and set the time as described above. <p>Note: To make Lock by Time active 24 hours a day, make Start Time and Stop Time the same.</p>



Front Panel

On, Off	<p>On locks and Off unlocks the controls on the front of the TV. Use this option if small children may try to press TV buttons.</p> <p>If the remote control is unavailable, use the front-panel buttons to release the front panel lock by doing one of the following:</p> <ul style="list-style-type: none"> • If the TV is on, press and hold the MENU button for over eight seconds. A message will display to confirm release of the Front Panel Lock. • If the TV is off: <ul style="list-style-type: none"> ■ In Fast Power On Energy Mode, press and hold the MENU button on the front panel for over eight seconds. The TV will power on and release the lock. ■ In Low Power Energy Mode, press POWER on the front panel to turn on the TV. With the TV on, press and hold MENU on the front panel for over eight seconds.
----------------	---

6 NetCommand

About NetCommand

- NetCommand setup is optional.
- You can perform NetCommand setup when the TV first recognizes a device during Auto Input Sensing or at any convenient time afterward.
- NetCommand operates by sending remote control signals from the TV to your other devices via the IR emitters, telling the devices to play, record, change inputs, adjust volume, change channels, or perform other functions. All this is accomplished with the TV's remote control and the slide switch left in the TV position.
- The IR "Learning" feature of NetCommand allows the TV to determine the IR control signals for your A/V devices.
- NetCommand® can control IEEE 1394 devices by sending control signals over a FireWire® cable.
- You can choose the level of NetCommand control for your home theater.

Important Note on NetCommand

Be sure to connect the IR emitter cable to the TV and properly place the emitters so that NetCommand can control your devices. See the explanation on the following page.

- **Standard Setup.** Perform a standard setup if you:
 - ◆ Want NetCommand to control only a few devices, such as the TV, a playback device (like a DVD player), and a cable box. With this setup, you can use the TV's remote control to operate these devices.
 - ◆ Want the ease and flexibility of NetCommand-controlled recording, with seamless setup of time-delayed or immediate recordings among networked devices.
 - ◆ Want to use TV Guide On Screen to control your VCR or A/V disc. After performing this setup, you can use the TV's remote control to operate these devices.
- **A/V Receiver Setup.** Perform A/V receiver setup if you want NetCommand to:
 - ◆ Control a surround sound A/V receiver.
 - ◆ Automatically change audio input selections on an A/V receiver when you change inputs on the TV.

IR Emitter Placement (NetCommand)

An IR emitter cable is included with the TV.

The NetCommand system uses emitters connected to the **IR EMITTER** jack to control other devices such as DVD players, cable boxes, satellite receivers, and VCRs.

1. Connect the plug end of the supplied IR emitter cable to the **IR EMITTER NetCommand®** jack on the TV back panel.
2. Run the cable for each of the emitter ends under, alongside, or over each device to be controlled so that the emitter end is in front of the area where the remote control sensor is located.
3. Position the emitter end with the emitter bulb facing the remote control sensor. The bulb emits infrared light in a cone-shaped pattern. Place the bulb far enough from the sensor to allow the cone pattern to reach the sensor.

The IR sensor is usually behind the plastic window of the front display panel. It is sometimes visible with the aid of a flashlight and is normally a round or square cutout behind the plastic.

If you cannot see the sensor and the device's Owner's Guide does not specify the location, you can find it by following these steps using the device's remote control:

- a. Hold the device's remote about one-half inch from the front of the device. Starting from one end of the display window plastic, press the **POWER** button.
- b. If the device does not respond, move the remote control one inch toward the center and try again.
- c. Repeat this until the device responds.
- d. Note this location and then start over from the other end of the display window plastic, repeating until the device responds again.

The remote control sensor is somewhere between these two positions. This is usually enough accuracy for placement of the IR emitters.

In some cases, the emitter works better facing downward from the top of the device. Experiment to find what works best.

4. Secure the emitter ends in place using double-sided tape.
5. Place any unused ends behind the devices to prevent stray signals from reaching the IR sensors.

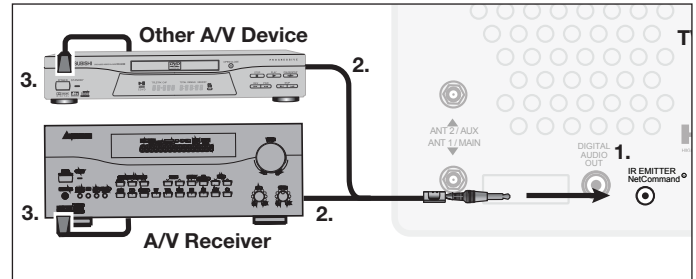

Connecting IR Emitter NetCommand

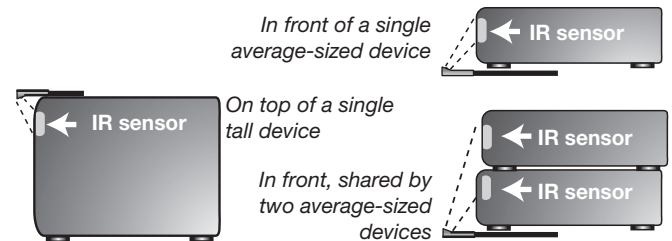

Place IR emitters so the signal can be "seen" by the IR sensor on each device.

IMPORTANT

Position IR emitters so that each device's sensor "sees" the signal from only one emitter. Otherwise, a device receiving signals from multiple sources (remote controls, IR emitters) may not respond at all.

Initial NetCommand Setup for Most Devices

To perform this procedure, you need:

- The remote controls for both the TV and the device you want to control.
- The IR emitter cable supplied with the TV.

Note: To set up an A/V receiver, see “Set Up NetCommand Control of an A/V Receiver” later in this chapter.

1. Connect and position the IR emitters for the devices you wish to control. See “IR Emitter Placement” in this chapter.
2. Set the **TV’s** remote control slide switch to the **TV** position.
3. Open the NetCommand **Learn** screen in one of two ways:
 - If working from the **Auto Input Sensing** screen for the device, highlight the **Learn** icon and press **ENTER** to open the **Learn** screen for the device.
 - If performing NetCommand setup at any time after the device has been recognized through Auto Input Sensing:
 - a. Press **INPUT** to open the **Input Selection** menu.
 - b. Highlight the desired input icon and press **ENTER** to switch to that input.
 - c. Press **MENU**, highlight **Inputs**, and highlight **Learn** to open the **Learn** screen for the device.
4. The first function highlighted in the **Learn** screen is always **Power On**. Aim the **TV’s** remote control at the TV and press **ENTER** to begin learning for that function.
5. When the **Power On** text starts flashing, aim the **device’s** remote control at the TV and press and hold the **POWER** key until a check mark appears next to **Power On**.
 - If the text stops flashing before the check mark appears, repeat this step.
 - To remove the key from NetCommand control, press the **CANCEL** key while the key name is highlighted.
6. Press the **▲▼◀▶** keys on the **TV’s** remote control to highlight other keys on the list. Repeat steps 4 and 5 for each additional function you wish to control through NetCommand.
7. If the device’s remote control has keys that are not in the list, you can associate up to any four keys with the **F1** through **F4** keys.

For example, for a DVD player, assign the **F1** and **F2** keys to the DVD player’s **CHAPTER SKIP FORWARD** and **CHAPTER SKIP BACK** keys. Perform NetCommand setup

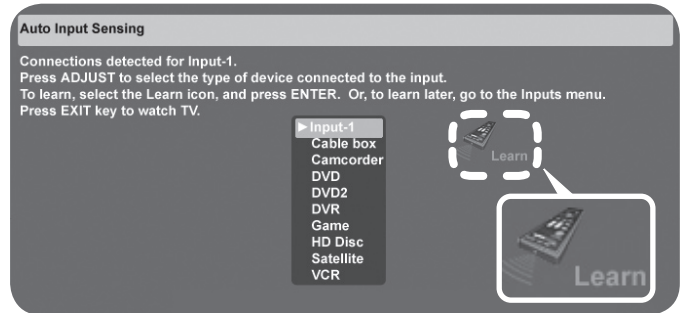

From the **Auto Input Sensing** screen, highlight the **Learn** icon and press **ENTER** to open the **NetCommand Learn** screen.

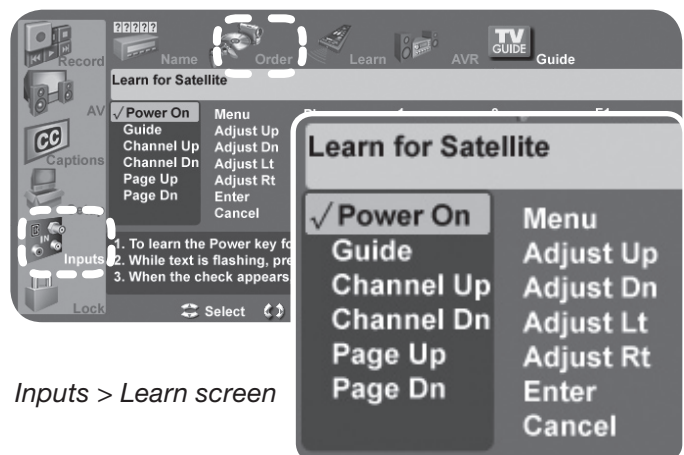

8. The first function highlighted in the **Learn** screen is always **Power On**. Aim the **TV’s** remote control at the TV and press **ENTER** to begin learning for that function.
9. When the **Power On** text starts flashing, aim the **device’s** remote control at the TV and press and hold the **POWER** key until a check mark appears next to **Power On**.
 - If the text stops flashing before the check mark appears, repeat this step.
 - To remove the key from NetCommand control, press the **CANCEL** key while the key name is highlighted.
10. Press the **▲▼◀▶** keys on the **TV’s** remote control to highlight other keys on the list. Repeat steps 4 and 5 for each additional function you wish to control through NetCommand.
11. If the device’s remote control has keys that are not in the list, you can associate up to any four keys with the **F1** through **F4** keys.
12. For example, for a DVD player, assign the **F1** and **F2** keys to the DVD player’s **CHAPTER SKIP FORWARD** and **CHAPTER SKIP BACK** keys. Perform NetCommand setup for the **F** keys the same as you did for the named keys.
13. If the device has a separate **POWER OFF** key, press **▲▼◀▶** on the **TV’s** remote to highlight **Power Off**. Repeat the earlier steps to “learn” the **POWER OFF** key. **If the device has no POWER OFF key, skip this step.**
14. Press **EXIT** to finish NetCommand “learning” for the current device.















Add or Remove Device Keys from NetCommand Control

1. Press **INPUT** to open the **Input Selection** menu and select the affected device.
2. Open the **Inputs** menu and highlight the **Learn** icon.
3. When the **Learn** screen displays:
 - To add keys: Continue as described earlier under “Initial NetCommand Setup for Most Device Types.”
 - To delete keys: Highlight the name of the key you wish to delete and press **CANCEL** on the **TV’s** remote control to clear the check mark.

NetCommand Specialized Device Keys

Refer to this chart when “learning” device keys. “Learn” some, all, or none of the keys used for each device type. The chart has space for you to write in functions you assign to the F1–F4 keys.

See the following page for more on keys marked in the “Special Operation Method” column.

Key Name in Learning Screen	Function	Name on TV Remote Control	See Special Operation Method Table
Power On	Power On or Power ON/OFF (toggle)	POWER	*
Guide	On Screen Program Guide or DVD Disc Menus	GUIDE	*
Channel Up	Next Channel Higher	CH/PAGE 	
Channel Dn	Next Channel Lower	CH/PAGE 	
Page Up	Page Up in Guides	CH/PAGE 	*
Page Dn	Page Down in Guides	CH/PAGE 	*
Menu	Setup menu for device	MENU	*
Adjust Up	Adjust or arrow up		
Adjust Dn	Adjust or arrow down		
Adjust Lt	Adjust or arrow left		
Adjust Rt	Adjust or arrow right		
Enter	Enter or Select (menus)	ENTER	*
Cancel	Cancel or erase (menus)	-/CANCEL	*
Play	Start playback		
Stop	Stop playback		
Forward	Fast Forward		
Rewind	Rewind/Fast Reverse		
Pause	Pause playback		
Record	Start Recording		
1, 2, 3, 4, 5, 6, 7, 8, 9, 0	Digit functions	1, 2, 3, 4, 5, 6, 7, 8, 9, 0	
Enter (digits)	Use after digits to directly access channels by number	ENTER	*
- (separator)	Add digital channel separator between main channel number and sub-channel number	-/CANCEL	*
Recall (QV)	Last Channel Recall	QV	
Info	On-screen status display or information display	INFO	May require two keypresses
F1	ASSIGN YOUR CHOICE OF SPECIALIZED FUNCTIONS	F1	
F2		F2	
F3		F3	
F4		F4	
Power Off	Power Off	POWER	

Operating NetCommand-Controlled Devices

To Control Most Device Types

As an example of NetCommand control, if you are watching your cable box and you wish to tune to the next channel higher, press **CH/PAGE** \wedge . NetCommand then sends the “learned” channel-up control signal to the cable box.

1. With an IR emitter properly positioned in front of the device, use the **Inputs > Learn** screen to perform NetCommand setup for the device.
2. When you wish to use the device, press **INPUT** to display the **Input Selection** menu.
3. Press $\blacktriangle \blacktriangledown \blacktriangleleft \blacktriangleright$ to highlight the icon for the device.
4. Press **ENTER** to switch the TV to the device.
Note: if you have set up automatic input switching for the A/V receiver, the A/V receiver will automatically switch to the correct input for the device.
5. To operate the device using the **TV's** remote control, set the slide switch to the **TV** position.
6. Point the remote control at the **TV** (not the device) and press the key for the desired function.

Special Operation Methods

Key Name in Learning Screen	Special Operation Description and Setup	How to Use
Power On	Manual Power On/Off Use for devices that have only one POWER key.	<ol style="list-style-type: none"> 1. Press INPUT to display the Input Selection menu. 2. Press $\blacktriangle \blacktriangledown \blacktriangleleft \blacktriangleright$ to highlight the icon for the device to be powered on or off. 3. With the Input Selection menu still displayed, press POWER to send the power signal; you may need to press POWER twice. Note: If you press POWER without the Input Selection displayed, the TV will turn off. 4. Press ENTER to switch the TV to the device.
Power On Power Off	Automatic Power On/Off This feature is only for devices that have separate POWER ON and POWER OFF keys on their original remote controls. If your device does not have a separate POWER OFF key, do not use the Power Off learning position; use only the Manual Power ON/OFF method described above. In the NetCommand Learn screen: <ol style="list-style-type: none"> a. “Learn” the Power On command in the Power On learning position. b. “Learn” the Power Off command in the Power Off learning position. 	<ul style="list-style-type: none"> • To Power On the Device <ol style="list-style-type: none"> 1. Press INPUT to display the Input Selection menu. 2. Press $\blacktriangle \blacktriangledown \blacktriangleleft \blacktriangleright$ to highlight the icon for the device to be powered on or off. 3. Press ENTER to switch the TV to the device and NetCommand will send the Power On command to the device. • To Power Off the Device When you turn the TV off, the TV sends all learned Power Off commands to all devices.
Menu	Displaying the Menu for a Device	<ol style="list-style-type: none"> 1. While watching a device, press INPUT to display the Input Selection menu with the device icon highlighted. 2. Press MENU to send the menu signal to the device. The Input Selection menu will automatically clear from the screen.

To Control an A/V Receiver

Switching Audio to and from the A/V Receiver

1. Press **AUDIO**.
2. Press \blacktriangle to show the **Speakers** option.
3. Press \blacktriangleright to select either **AV Receiver** or **TV**.

Controlling A/V Receiver Power

1. Press **AUDIO**.
2. Press $\blacktriangle \blacktriangledown$ to show the **Speakers** option.
3. Press \blacktriangleright to select **AV Receiver**.
4. Point the remote control at the **TV** (not the A/V receiver) and press **POWER** to power the A/V receiver on or off

Controlling Other A/V Receiver Functions

With the A/V receiver powered on and selected, the TV's remote operates the volume and mute functions. Also, when you switch to a device in the **Input Selection** menu, the A/V receiver automatically switches to the correct audio input for the device.

Operating NetCommand-Controlled Devices, continued

Key Name in Learning Screen	Special Operation Description and Setup	How to Use
Guide	<p>Displaying the Disc Menu (DVD or high-definition disc format)</p> <p>“Learn” the DISC MENU, TOP MENU, or other key as named on the original remote in the Guide learning position.</p>	While watching the device, press GUIDE to display the disc menu.
	<p>Displaying the On-Screen Program Guide (cable box or satellite receiver)</p> <ol style="list-style-type: none"> “Learn” the GUIDE key on the original remote in the Guide learning position. Learn the PAGE ^ and PAGE v keys of the original remote in the Page Up and Page Dn learning positions. 	<ol style="list-style-type: none"> While watching the device, press GUIDE to display the guide. Press CH/PAGE ^/v to send the Page Up/Dn commands for the guide.
Page Up Page Dn	<p>Using Page Up/Down</p> <p>If the device’s original remote control has separate keys for Channel Up/Dn and Page Up/Dn, the TV remote control’s CH/PAGE ^/v key can work like the two separate keys.</p> <ol style="list-style-type: none"> “Learn” CHANNEL ^/v in the Channel Up/Dn positions. “Learn” PAGE ^/v in the Page Up/Dn positions. 	<p>Inside the Guide</p> <p>Press CH/PAGE ^/v to send the Page Up/Dn commands.</p> <p>Outside the Guide</p> <p>Press CH/PAGE ^/v to send the Channel Up/Dn signal.</p>
Enter	<p>Enter Functions (cable boxes, satellite receivers, etc.)</p> <p>Some devices have two keys that have “enter” functions. One key is for menus and is often labelled SELECT or OK. A second key is for use with number keys for direct channel selection. NetCommand uses the same ENTER key for both operations.</p> <p>When ENTER has a menu or guide function or when the original remote control uses the same key for menus and channel selection:</p> <p>Learn the ENTER, SELECT, or OK key in the NetCommand Enter learning position.</p>	<ol style="list-style-type: none"> Press MENU or GUIDE to display the device’s menu or guide. Press ENTER within the menu and NetCommand will send the Enter signal for menus.
Enter (digits)	<p>When ENTER is for channel changes, i.e., the original remote control has a separate ENTER key for this function):</p> <p>Learn the ENTER key for channel selection in the NetCommand Enter (digits) learning position. Use this learning position only if the original remote control has separate keys for Enter in menus and Enter for channel selection.</p>	Press digit key(s) and then press ENTER . NetCommand will send the Enter signal for channel selection.
Cancel	<p>CANCEL as the Cancel or Exit Function</p> <p>“Learn” the Cancel or Exit function in the NetCommand Cancel learning position</p>	<ol style="list-style-type: none"> Press MENU or GUIDE to display the menu or guide. Press CANCEL and NetCommand will send the Cancel or Exit signal.
– (separator)	<p>The symbol “–” can serve as the separator between a digital channel’s main and sub-channel digits, e.g., digital channel 12-1 (main channel is 12, sub-channel is 1).</p> <p>“Learn” the channel separator function in the NetCommand – (separator) learning position.</p>	Press digit key(s) and press CANCEL . NetCommand will send the channel-separator signal.

Setting Up NetCommand Control of an A/V Receiver

Perform this setup to:

- Operate the A/V receiver's power and volume functions with the TV's remote control.
- Enable the A/V receiver to switch automatically to the correct audio input when you select a device in the TV's **Input Selection** menu.

To set up control of an A/V receiver you need:

- The remote controls for both the TV and the A/V receiver.
- The IR emitter cable supplied with the TV.

Note: To set up control of other device types, see "Initial NetCommand Setup for Most Devices" earlier in this chapter.

Perform this setup using the **Inputs > AVR** screen, shown below.

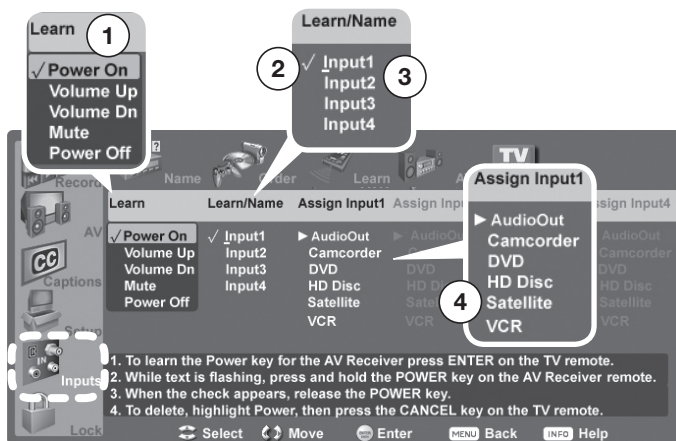

AVR screen overview

1. Power and volume commands the TV can send to the A/V receiver when "learned"
2. A check under **Learn/Name** means the TV has "learned" the command to switch the A/V receiver to the input.
3. **Input1** through **Input4** are temporary placeholder names for A/V receiver inputs. Use this screen to assign meaningful names, e.g., the name of the A/V receiver input.
4. Match up devices connected to the TV inputs with audio inputs on the A/V receiver.

Setup to Control the A/V Receiver's Power and Volume Functions

1. Connect your A/V receiver to the TV and any additional devices. See chapter 3, "TV Connections," for suggestions.
2. Connect the IR emitter cable to the TV and position the IR emitter where it can send signals to the A/V receiver.

3. Set the **TV's** remote control slide switch to the TV position.
4. Open the **AVR** screen in one of two ways:
 - If using the **Auto Output Sensing** screen for the A/V receiver, highlight the **Learn** icon and press **ENTER** to open the **AVR** screen.
 - If performing NetCommand setup at any time after the A/V receiver has been recognized through Auto Input Sensing: Press **MENU**, highlight **Inputs**, and highlight **AVR** to open the **AVR** screen.
5. The first function highlighted in the **AVR** screen is always **Power On**. Aim the **TV's** remote control at the TV and press **ENTER** to begin learning for **Power On**.

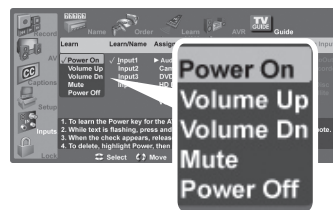

A/V Receiver (AVR) screen. Perform NetCommand IR "learning" for A/V receiver power and volume keys.

6. When the **Power On** text starts flashing, aim the **A/V receiver's** remote control at the TV and press and hold the **POWER** or **POWER ON** key until a check mark appears next to **Power On**.
 - If the text stops flashing before the check mark appears, repeat this step.
 - To remove the key from NetCommand control, press the **CANCEL** key while the key name is highlighted.

By completing "learning" for the power key, NetCommand now operates the power function for the A/V receiver.

Point the TV's remote control at the TV to control the A/V receiver.

7. Press the **▼** key on the **TV's** remote control to highlight other keys in the list. Repeat steps 5 and 6 for each additional function you wish to control through NetCommand.
8. If the A/V receiver has a separate **POWER OFF** key, press **▼** on the **TV's** remote to highlight **Power Off**. Repeat steps 5 and 6 to "learn" the **POWER OFF** key.
9. When finished "learning" the power and volume keys, either press **EXIT** to watch TV or proceed to the next section to continue NetCommand setup of the A/V receiver.

Setting Up NetCommand Control of an A/V Receiver, continued

Setup to Control Automatic Switching of A/V Receiver Audio Inputs

Two different setups are described here:

Setup 1: Automatic A/V Receiver Switching to TV Audio Input

Setup 2: Automatic A/V Receiver Switching for a device sending audio directly to the A/V receiver

- **Audio Available from TV only: Use Setup 1.**

Audio from **ANT 1** and **ANT 2** must be sent to the A/V receiver from the TV's **DIGITAL AUDIO OUT** or analog **AVR AUDIO OUTPUT**.

Use Setup 1 to make the A/V receiver switch to its designated TV audio input when viewing these sources.

- **HDMI Digital Stereo Audio: Use Setup 1**

Digital stereo audio from an HDMI connection is available both in digital format (from the TV's **DIGITAL AUDIO OUT**) jack and in analog format (from the TV's **AVR AUDIO OUTPUT** jack).

- **Analog Stereo Audio: Use Setup 1.**

Audio from sources with only analog stereo output (such as a VCR) can be sent either directly to the A/V receiver or through to the TV and then on to the A/V receiver.

Mitsubishi recommends you send audio through the TV as shown in the example. Setup 1 causes the A/V receiver to switch to its input designated for TV audio.

If you have a digital A/V receiver, the TV makes the audio available by converting analog audio to a digital output.

- **Digital Surround Sound: Use Setup 2.**

A device can send digital surround sound such as Dolby Digital or DTS directly to the A/V receiver, bypassing the TV entirely. The device might be a DVD player, cable box, or satellite receiver, and

could have HDMI output. A DVD player is used in this example.

Your setup may include additional devices with digital surround sound connected directly to the A/V receiver. These devices might be a DVD player plus a cable box or satellite receiver.

Before You Begin

1. Connect your A/V devices to the TV and connect your A/V receiver to the audio outputs on the TV and the DVD player. See chapter 3, "TV Connections," for suggestions.
2. Open the **Inputs > AVR** menu.

Note: The terms **Input 1–Input 4** used in the **AVR** screen are temporary placeholder names. They refer to the A/V receiver inputs for which the TV can learn IR codes.

Setup 1: Automatic A/V Receiver Switching to Its TV Audio Input

Most devices are set up like the VCR in this example, in which analog audio from the device is sent through the TV.

Use this setup for:

- Sources providing only analog stereo output, such as a VCR.
- Audio from **ANT 1** and **ANT 2**

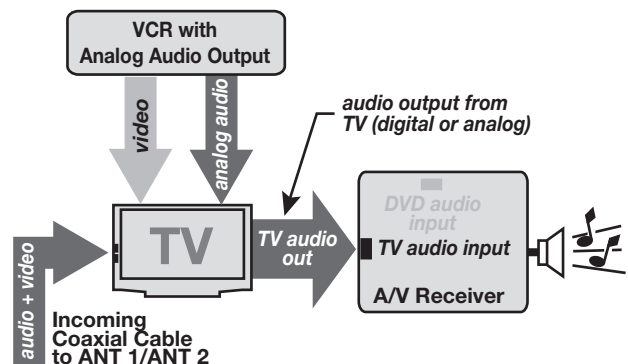

Setup 1: A/V receiver audio from the TV's digital or analog audio output (**DIGITAL AUDIO OUT** or **AVR AUDIO OUTPUT**)

1. Under **Learn/Name**, navigate to highlight the area next to **Input 1**.
In this example, the IR code for the A/V receiver's **TV Audio** input will be "learned" as **Input 1**.
2. Press **ENTER** on the **TV's** remote control.
3. While the text **Input1** is flashing, press and hold the **TV INPUT** key on the **A/V receiver's** remote control.
4. When a check appears next to **Input 1**, release the **TV INPUT** key.
 - If the text stops flashing before the check mark appears, repeat this step.

IMPORTANT

To hear audio sent from the TV to the A/V receiver, you must have:

- physically connected the TV to the A/V receiver
- selected the A/V receiver as the audio source. Press **AUDIO**, then **▲ ▼** to show the **Speakers** option, then **▶** to select the **A/V Receiver**.
- "learned" the IR codes for the A/V receiver inputs
- chosen the correct input in the **NetCommand A/V Receiver Learn** screen

Setting Up NetCommand Control of an A/V Receiver, continued

- To erase the IR code just “learned,” press **CANCEL** while the name is highlighted.
- Press **▶** to highlight the name **Input1**. You can enter a custom name using the letters/numbers on the remote control. It is best to assign names to “learned” inputs that match the input names displayed on the A/V receiver. For this example, enter the custom name **TV** using these guidelines:
 - To select a character, repeatedly press a number key on the remote control to cycle through the characters associated with the key. Special characters are available with the **1** key (!, &, blank space) and **0** key (/,*,-).
 - Press **ENTER** to set the character and move the highlight to the next character.
 - To delete a character, highlight the character and press **CANCEL**.
 - To highlight the first character, repeatedly press **CANCEL**.
 - Press **▶** to move the highlight to the **Assign** column.
 - Use **▲▼** to highlight **AudioOut** (TV audio output). The triangular marker is always next to the assigned sound source.
 - Press **EXIT** if finished or continue with setup for another TV source.

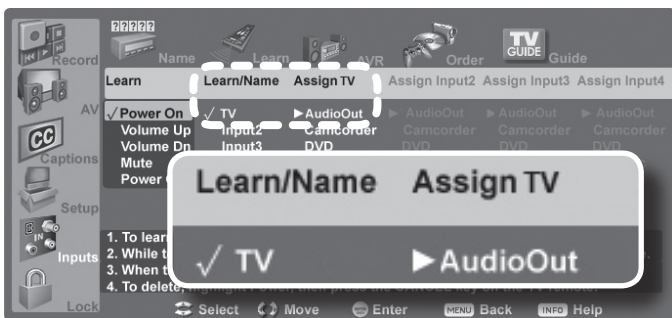

Completed NetCommand setup described for controlling A/V receiver switching to the A/V receiver's audio input labelled “TV.”

Setup 2: Automatic A/V Receiver Switching for a Surround Sound Device

Use this setup to send digital surround sound directly from a device to an A/V receiver.

- Under **Learn/Name**, navigate to highlight the area next to **Input2**.
In this example, the IR code for the A/V receiver's **DVD Audio** input will be “learned” as **Input 2**.
- Press **ENTER** on the **TV's** remote control.

IMPORTANT

All audio from what you are watching on the TV is always available as an output on both the TV's **AVR AUDIO OUTPUT** and **DIGITAL AUDIO OUT** jacks.

To use the digital surround sound capabilities of your A/V receiver however, you must connect your **DVD player, satellite receiver, or cable box** directly to the A/V receiver, as surround sound may not be available from the TV's audio output.

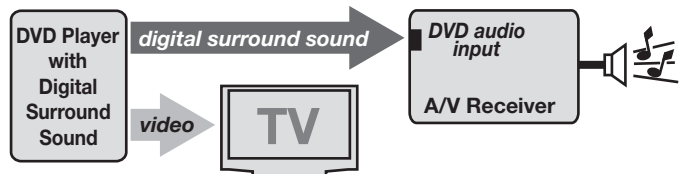

Setup 2: A/V receiver audio from a device providing surround sound directly to the A/V receiver

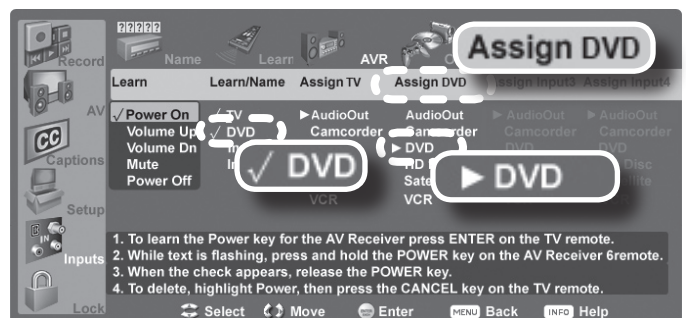

Completed NetCommand setup described for controlling A/V receiver switching to an A/V receiver input labelled “DVD.”

- While the text **Input2** is flashing, press and hold the **DVD INPUT** key on the **A/V receiver's** remote control.
- When a check appears next to **Input 2**, release the **DVD INPUT** key.
 - If the text stops flashing before the check mark appears, repeat this step.
 - To erase the IR code just “learned,” press **CANCEL** while the name is highlighted.
- Press **▶** to highlight the name **Input2**. Assign a custom name that matches the input name displayed on the A/V receiver. For this example, enter the custom name **DVD** using the number keys and the guidelines given earlier.
- Press **▶** to move the highlight to the second **Assign** column.
- Use **▲▼** to highlight **DVD** in the list of devices recognized by the TV. The triangular marker always shows the assigned sound source.
- Press **EXIT** if finished or continue for additional TV sources.

NetCommand-Controlled Recording

This section describes making recordings independently of the TV Guide On Screen system. For instructions on setting up recordings using TV Guide On Screen, see the separate *TV Guide On Screen® Interactive Program Guide User's Manual*.

Before You Begin

For best results, review this list of factors that may affect your recordings.

Recordable Inputs

You can record from the **ANT 1** or **ANT 2** jacks, the **INPUT 1-3** jacks, or the IEEE 1394 inputs.

Note: Signals received on the HDMI and component inputs cannot be recorded.

Analog vs. Digital Recording Devices

- Analog programs can be recorded only to analog devices. Analog sources cannot be recorded to digital devices. Connect your analog recording device to the TV's **RECORD OUTPUT** jacks.
- Digital programs can be recorded on either digital or analog devices. For best playback quality, however, record digital programs on digital recording devices. Connect your digital recording devices to the TV's IEEE 1394 jacks.

Analog Recording Formats

If you record from a digital 16:9 channel to an analog VCR or recording device, select a recording format based on the type of TV you will use for playback. You must choose a format for analog recording because of the mismatch between the 16:9 ratio of the digital source picture and the narrower 4:3 ratio of the analog recorder.

Choose the analog recording format in the **Record > Setup** menu. Your choices are:

- **Anamorphic.** For anamorphic (widescreen) playback on this widescreen TV. Ensure that the TV screen format is set to standard (see the section on TV formats in this Owner's Guide).
- **Cropped.** For cropped playback on an older-style 4:3 TV. The cropped display removes the top and bottom sections of the picture. This setting does not affect recording from analog devices, analog channels, or 4:3 digital channels.

Copy-Protected Material

When attempting to record copy-protected material, the record functions of the NetCommand and IEEE 1394 systems may be prevented or stopped.

Making a Recording

You can start a recording immediately or you can schedule it to take place at a later time and set the duration of the recording in 30-minute increments. The default is one hour. While recording, you can view a different device or power off the TV.

Immediate Recording

1. Switch the TV to the program source by using the **Input Selection** menu.
 - a. Press **INPUT** to display the **Input Selection** menu.
 - b. Highlight the icon for the program source and press **ENTER** to switch to the program source.
 - c. Change the channel if needed.
2. Press **MENU** and **▶** to display the **Record > Schedule** menu.
3. Review the recording settings and change if needed.
4. Press **⏻** to start recording.

Time-Delayed Recording

You can schedule up to 32 recordings.

1. Ensure that TV Energy Mode is set to **Fast Power On** and the TV clock is set to the correct time and day. Use the **Setup** menu to make any needed changes.
2. Switch the TV to the program source by using the **Input Selection** menu.
 - a. Press **INPUT** to display the **Input Selection** menu.
 - b. Highlight the icon for the program source and press **ENTER** to switch to the program source.
3. Press **MENU** and **▶** to display the **Record > Schedule** menu.
4. Review the **Channel**, **Record To**, and **Duration** settings. Change settings if needed. See the information box "Using the Record > Schedule Menu."
5. Set the **Start Time** and **Day**.
6. Highlight **ADD** and press **ENTER** to add the recording to the Record List. A confirmation message will be displayed if your selection is successful.

If you picked overlapping times, day(s), or destination devices, you will see a message stating there is a conflict. To cancel the conflicting recording, press **MENU** and **▶** to display the **Record > List** menu. Highlight the conflicting recording and press **CANCEL**.
6. Review the Record List to confirm that the recording is now in the schedule.
 - a. Press **MENU** to move the highlight to the top row of icons in the Record menu.

NetCommand-Controlled Recording, continued

- b. Highlight **List** to display the Record List.
7. Press **MENU** to return to the top row of icons or press **EXIT** to return to TV viewing.

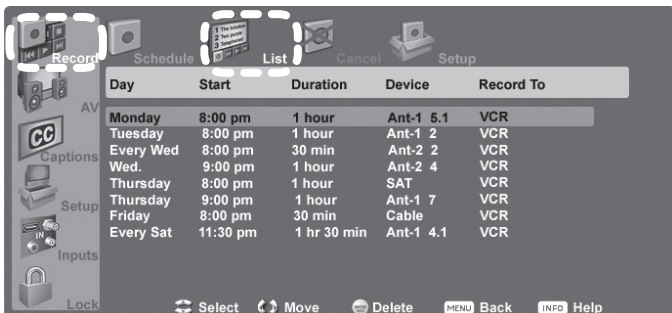

Record List

TV Guide On Screen and the Record List

Programs scheduled through TV Guide On Screen do not appear in the Record List. Refer to the separate *TV Guide On Screen® Interactive Program Guide User's Manual* for information regarding scheduling recordings with TV Guide On Screen.

If there is a conflict between a recording scheduled through TV Guide On Screen and the Record List, the TV Guide On Screen recording takes priority.

Cancelling Recordings

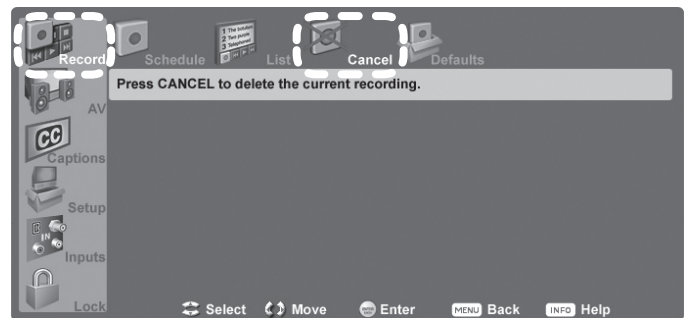

Use the Record menu's Cancel option to cancel a recording in progress.

To Cancel a Recording in Progress

1. Press **MENU** and then press **▶** to highlight the **Record** menu **Cancel** icon.
2. Press **CANCEL**.

To Cancel a Scheduled Recording

1. Press **MENU** and then press **▶** to highlight the **Record** menu **List** icon.
2. Use **▲▼** to highlight the recording you wish to cancel.
3. Press **CANCEL**.
4. Press **EXIT** to close the menu.

Using the Record > Schedule Menu

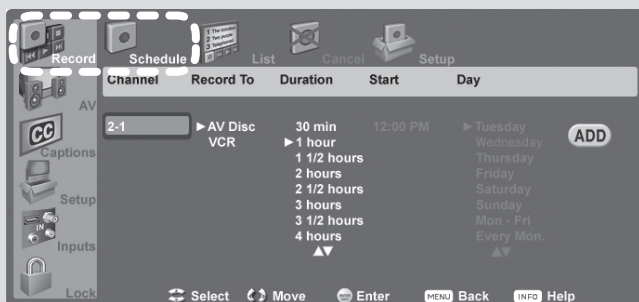

The Record > Schedule menu

To display the menu:

- Press **MENU**, highlight the Record icon, then highlight **Schedule**.
- or
- Press **Ⓞ** (**RECORD**) (available only if the key has not already been “learned” for another device).
- Press **▼** to move the highlight into the lower part of the menu.
- Press **MENU** to move the highlight back to the top row of icons.

- Press **▲▼◀▶** to highlight each option you need to change:
 - **Channel.** If the source is an antenna, select a memorized channel using **▲▼, CH ^/▼**, or enter the channel number from the remote control and press **ENTER**.
 - **Record To.** If you have more than one recording device connected to the TV, use **▲▼** to select it.
 - **Duration.** Use **▲▼** to select a recording duration of from 30 minutes to six hours in 30-minute increments. The default is one hour.
 - **Start Time (for future recordings)**
 - a. With the hour highlighted, press **▲▼** to change the hour, including **AM** or **PM**. Press **ENTER** to set the hour and move the highlight to the minutes.
 - b. With the minutes highlighted, press **▲▼** to change the minutes.
 - **Day (for future recordings).** Use **▲▼** to select a day of the week.
 - **ADD.** Highlight **ADD** and press **ENTER** to add a recording to the Record List.

NetCommand-Controlled Recording, continued

Recording from ChannelView™

ChannelView™ is available when TV Guide On Screen is disabled. ChannelView provides program listings, as sent by the broadcasters, for memorized channels on **ANT 1** and **ANT 2**. Press the **GUIDE** key while watching **ANT 1** or **ANT 2** to see ChannelView listings and to set up immediate or future recordings as described here.

Immediate Recording from ChannelView

- Switch the TV to the program source by using the **Input Selection** menu.
 - Press **INPUT** to display the **Input Selection** menu.
 - Highlight the icon for the antenna and press **ENTER** to switch to the program source.
- Press **GUIDE** to view ChannelView listings for the current input.
- Use **▲▼** to highlight the channel and program you wish to record.
- Press **RECORD**. The TV will tune to the channel if needed. A red “R” briefly appears next to the program listing to indicate the program will be recorded.
- Press **EXIT** to return to TV viewing.

Time-Delayed Recording from ChannelView

Set Up the Recording

- Ensure that TV Energy Mode is set to **Fast Power On** and the TV clock is set to the correct time and day. See “Setup Menu” in chapter 5, “TV Menu Settings.”
- Press **GUIDE** to view ChannelView listings for the current input.
- Press **▲▼** to highlight the source channel from which you wish to record.
- Press **▶** to view a list of future programs on that channel.
- Press **▲▼** to highlight a future program.
- Press **RECORD**. A red “R” temporarily displays next to the program listing to indicate the program will be recorded.

A red “R” appears briefly in ChannelView to indicate a scheduled recording.

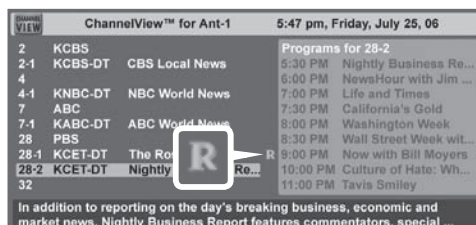

- Review the Record List to confirm that the recording is now in the schedule. To view the Record List:
 - Press **MENU** to display the Record menu.

- Highlight **List** to display the Record List.

- Press **MENU** to return to the top row of icons or press **EXIT** to return to TV viewing.

More on VCR Recording

Setting Up Analog VCR Recordings with TV Guide On Screen

When setting up a recording using TV Guide On Screen, note that:

- You must select the desired recording device in the TV Guide On Screen **Record Options** menu. If you have both analog and digital recording devices, always verify that the analog device is the TV Guide On Screen default device before starting an analog recording with the **RECORD** key.
- The destination recording device for analog recordings must be the analog device connected to the TV's **RECORD OUTPUT** jacks.

Restrictions for Traditional VCRs with NetCommand- and TV Guide On Screen-Controlled Recording

- Your VCR must be connected directly to the **RECORD OUTPUT** audio and video outputs.
- If the source device or recording device does not have separate power on and off controls, then leave the device powered on.

Direct VCR Recording from an Antenna or Cable Source

You can use this method when the VCR is connected to receive programming from a cable box, direct cable, or over-the-air antenna. When your VCR is the current device and the TV remote control's **RECORD** key has been “learned” for the VCR, the TV's remote works the same as the record button on the VCR.

- Press **INPUT** on the TV's remote to display the **Input Selection** menu. Highlight the traditional VCR and press **POWER** to turn on the VCR.
- Press **ENTER** to switch the TV to the VCR.
- Change the VCR's tuner to the channel you wish to record.
- Press **RECORD** to start recording. You will need to stop the recording manually at the end of the program.

Using IEEE 1394 Devices

IEEE 1394 Devices in the Input Selection Menu

Some non-audio/video or incompatible IEEE 1394 devices, such as personal computers (PCs), may not be detected by the TV and do not appear in the **Input Selection** menu. Such devices can, however, coexist with and work with compatible devices on the IEEE 1394 network.

An IEEE 1394 device may be a combination of two or more types of devices, called sub-units, such as a recording device that is also a tuning device. Each sub-unit is recognized as a separate device by the TV's Auto Input Sensing feature and appears as a separate device in the **Input Selection** menu.

To Power On or Off a Compatible IEEE 1394 Device

Usually, compatible IEEE 1394 devices power on when selected in the **Input Selection** menu and power off when you turn off the TV. If you need manual control over power on/off:

1. Press **INPUT** to open the **Input Selection** menu.
2. Move the highlight to the icon for the device. There is no need to press **ENTER**.
3. Press **POWER**.
4. Press **EXIT** to return to TV viewing.

Operation of IEEE 1394 Devices with the TV's Remote Control

(slide switch set to TV position)

Device → Remote Control Key	CABLE/SAT*	A/V DISC	DVCR	AMPLIFIER (some MPEG2 models only)
POWER	Power the device on/off when highlighted in the Input selection menu. See the instructions above.			
CH ▲/▼	Channel up/down	Page up/down (when track list is displayed)	Index search forward/reverse (if supported by DVCR)	
VOL ▲/▼				Volume Up/Down
MUTE				Mute On/Off
0-9 (DIGITS)	Number functions	Search by time (when followed by ENTER)		
QV	Last Channel Recall			
EXIT	Exit menus/displays	Exit menus/displays	Exit menus/displays	
ENTER	Enter or select	Enter or select	Enter or select	
CANCEL	Cancel function	Delete recording from Track List	Cancel function or counter reset	
GUIDE	Digital-channel guide (may need to press twice)	Display Track List.		
▲ ▼ ◀ ▶	Up/down/left/right	▲ ▼ Skip to beginning or end of program ▲ ▼ Up/down in track list ◀ Skip Backwards 12 seconds during playback ▶ Skip Forward 30 seconds during playback	Up/down/left/right	
▶ PLAY		Play	Play	
■ STOP		Stop	Stop	
● RECORD		Record	Record	
◀ REV		Reverse picture scan or Slow Play	Reverse or Rewind	
▶ FFWD		Fast picture scan or Fast Play	Fast Play or Fast Forward	
⏸ PAUSE		Pause	Pause	

* For an IEEE 1394 cable box or satellite receiver, try using the **CABLE/SAT** position of the TV remote control to see if it can operate the device. If not, use the remote control that came with the device.

Using IEEE 1394 Devices, continued

Recording to IEEE 1394 Devices

You can use the TV's NetCommand recording functions to control recording to IEEE 1394 devices. The following table shows which signals can be recorded to an IEEE 1394 digital VCR or A/V disc.

Availability	Signal Type	TV Input
Recordable	Digital channels, including high-definition channels	ANT 1, ANT 2
	Digital signals, including high-definition signals	IEEE 1394 devices
Not Recordable	Analog channels	ANT 1, ANT 2
	Analog signals	INPUT 1-3, COMPONENT inputs
	Digital signals	HDMI inputs

A/V Discs

A/V Disc Track List Screen

When viewing an A/V Disc:

- Press **GUIDE** to display its Track List (see below).
- Press **▲** or **▼** to navigate through the Track List.
- To play a track, select it on the list, then press **ENTER**.
- Press **INFO** to view details for a highlighted track, if available.
- To move through listings quickly, press **PAGE ▲/▼**.
- To delete a track, highlight it and press **CANCEL**. Press **CANCEL** a second time to confirm.

Track List for AV Disc					Free Disk Space: 11G
Channel	Station	Date	Time	Program	
62	KNBC-DT	Su 5/6	8:00 pm	West Wing	
2.1	KCBS-DT	Su 5/20	5:30 pm	CBS Local News	
4.1	KNBC-DT	M 5/21	5:30 pm	NBC Evening News	
5.1	KTLA-DT	T 5/22	8:00 pm	Gilmore Girls	
11.1	KTTV-DT	T 5/22	9:00 pm	House	
28.1	KPBS-DT	T 5/22	11:30 pm	Tavis Smiley	
28.1	KPBS-DT	W 5/23	11:30 pm	Tavis Smiley	
5.1	KTLA-DT	Th 5/24	8:00 pm	Smallville	

60 min 6G COPY NEVER 2 DAYS
With the country at a heightened state of alert the President considers ...

A/V Disc Track List screen

A/V Disc Search by Time

To search to a specific time in a recording:

1. Start playing the desired track on the A/V disc.
2. Use the number keys to enter the time code of hours followed by minutes. For example, to start one hour and twenty-two minutes (1:22) into the track, enter 1, 2.
3. Press **ENTER** to skip to the time code position. To cancel the request or to start over, press **CANCEL**.

Copying A/V Disc Recordings

Tracks you record to disc may have copy restrictions assigned to them. To learn a track's copy restrictions, highlight the track in the Track List and press **INFO**. Tracks can be assigned one of these ratings:

Copy Free (or no status shown)	No copy restrictions apply.
Copy Never	The track cannot be transferred to another recording device. Tracks of this type may have an assigned retention period. See below.

The Track List may also display the copy status for a track. You may see the following status displays:

Copy Once	The track can be copied once only.
Copy No More	If a retention value is shown, the track may be movable using your other A/V equipment. Mitsubishi TVs do not support this function.

Retention Period

Some **Copy Never** tracks have a retention period assigned by the content provider. The retention period is the length of time you can keep and view the recording. The initial retention period, if any, is shown next to the copy status in the Track List **INFO** display. To check how much remains of the retention period, start viewing the recording and press **INFO**.

Note: The retention period for all tracks on the disc expires if there is any loss of power to the TV, even momentary. For example, expiration of the retention period will occur if you:

- Unplug the TV or recording device from the AC power source.
- Experience a power outage or fluctuation.

You can safely turn off TV power using the **POWER** key without affecting the retention period.

To Copy a Track to Another IEEE 1394 Device

1. Press **INPUT** on the remote control and press **▲ ▼ ◀ ▶** to select the source A/V disc. Press **GUIDE** to open the Track List if not already open.
2. Press **▲** or **▼** to select a track. Then press **ENTER** to start playback.
3. Press **(II)** (**PAUSE**) to pause playback.
4. Press **(RECORD)** on the TV remote. The **Record > Schedule** menu will display.
5. Under **Record To**, review the destination device (A/V Disc, DVCR). Change if necessary.
6. Set **Duration** to the length of the original track or longer.
7. Press **(RECORD)** a second time to start recording.

Appendix A: Specifications

Size, Weight, and Power Consumption					
Model	Dimensions (inches)			Weight (lbs.)	Power
	Height	Width	Depth		
WD-57833	35	51.3	13.9	62.4	275
WD-65833	39.5	58.2	15.4	78.0	275
WD-73833	43.6	65.2	17.5	92.6	275

Inputs		
Type	Qty.	Input Specifications
Antenna/Cable input	2	RF F connector, 75-ohm
HDMI (digital video/audio)	4	CEA-861D standard for digital audio and video via HDMI HDMI standard connector Video: 60 Hz: 480i, 480p, 720p, 1080i 24 Hz, 30 Hz, 60 Hz: 1080p Audio: PCM stereo PC (digital signals only): VGA (640 x 480, 60 Hz) W-VGA (848 x 480, 60 Hz) SVGA (800 x 600, 60 Hz) W-SVGA (1064 x 600, 60 Hz) XGA (1024 x 768, 60 Hz) 1280 x 720, 60 Hz SXGA (1280 x 1024, 60 Hz) 1920 x 1080 (24 Hz, 30 Hz, 60 Hz) WXGA (1360 x 768, 60 Hz)
Composite Video	3	NTSC 480i only Video: RCA Pin Plug, 1.0 V p-p, 75 ohm
S-Video	2	Four-Pin DIN Plug Y: 1.0 Vp-p 75-ohm C: 0.286 Vp-p (burst signal), 75-ohm
Component Video (Y/Pr/Pb)	3	CEA-770.1 & CEA 770.2 480i, 480p, CEA 770.3 720p and 1080i (TV analog component video standards) RCA Pin Plug Y: 1.0 Vp-p (includes sync), 75-ohm Pr: 700 mV p-p, 75-ohm Pb: 700 mV p-p, 75-ohm
USB Photo Port	1	For transfer of JPEG files only.
Audio Inputs	6 pairs	Analog left and right audio RCA Pin Plug 500 mV (full scale), 43-k ohm
IEEE 1394 (input/output)	2	IEEE 1394 Four-Pin-Type Terminal, S400
M-Link	1	RS-232 control

Outputs		
Description	Qty.	Output Specifications
Audio Speakers	2	5.75" x 2.4"

Outputs		
Description	Qty.	Output Specifications
Analog Audio (Signal)	1 pair	RCA Pin Plug, 500 mV rms \pm 200 mV (full scale) for analog sources, 1.5 Vrms \pm 0.5 Vrms (full scale) for digital sources.
Digital Audio Output	1	RCA Pin Plug, Signal Type Dolby Digital, PCM stereo
Record Output	Video	1 Video: RCA Pin Plug 1.0 Vp-p, 75-ohm Signal Type: NTSC 480i only
	Audio	1 pair RCA Pin Plug, 500 mV rms \pm 200 mV (full scale) for analog sources, 1.5 Vrms \pm 0.5 Vrms (full scale) for digital sources.
3-D Glasses Emitter	1	VESA 1997-11 Connector and Signal Standards for Stereoscopic Display Hardware

Image Technology	Lamp
DLP, 0.65" chip, 1920 x 1080 pixels with Smooth Picture™	180-watt VIP type

Channel Frequency Reception	Over-the-Air: VHF 2–13, UHF 14–69 Analog Cable: 1–125 Digital Cable: 1–135	
Channel Type*	Over the Air:	Analog NTSC, Digital ATSC with sub-channels (all 18 video formats)
	Cable:	Analog NTSC (non-scrambled) Digital QAM 64 and 256 with sub-channels (non-scrambled)
* Note for Digital Channels: The channel numbers displayed on screen are determined by the broadcaster or cable company and can vary from the standard frequency number. If there is no channel-number information provided by the broadcaster or cable company, the TV creates a channel number. The created channel number uses the frequency number as the main channel number and the program number as the sub-channel number.		

HDMI

The HDMI inputs are compliant with CEA-861D standards for standard, extended, and high-definition video; digital audio, and HDCP copy protection.

IEEE 1394 System Compatibility

- This television is designed to conform to IEEE 1394 AV/C Software standards in effect at the time of development. This networking and control technology is designed to provide high-performance digital connections and product control, making the product easier to use.
- Mitsubishi D-VHS VCRs are fully compatible with this TV in audio, video, and control.
- As other manufacturers distribute products that use the IEEE 1394 AV/C standards, they will be responsible for developing products that meet the standards of the technology, as well as compatibility testing with other products. Mitsubishi cannot be responsible for their efforts, and therefore cannot promise compatibility with these other products. Any compatibility problems with other manufacturers' products should be brought to the attention of those manufacturers.

Appendix B: Lamp-Cartridge Replacement and Cleaning

WARNING

THE ACCESS PANEL IS PROVIDED WITH AN INTERLOCK TO REDUCE THE RISK OF EXCESSIVE ULTRAVIOLET RADIATION. DO NOT DEFEAT ITS PURPOSE OR ATTEMPT TO SERVICE WITHOUT REMOVING PANEL COMPLETELY.



CAUTION



BURN DANGER! HOT SURFACES INSIDE!

Touch lamp cartridge handle only. Do not touch lamp or lamp cartridge housing. Keep lamp cartridge horizontal during removal. Do not tilt as glass may come out and cause injury. Only replace lamp cartridge with the same part number 915P061010.

CAUTION: If the television is on, press **POWER** to turn it off. Unplug the television and allow it to cool for at least one hour before attempting to replace the lamp cartridge.

Lamp Life

The light source for this television is a lamp, which is part of a lamp cartridge assembly. The life of the lamp can vary, based on the lamp itself, the air temperature around the TV while it is operating, the selected lamp mode, and your viewing patterns. Warmer air or poor ventilation shorten the lamp life, as does use of the **Bright** lamp mode and turning the television on and off frequently. Mitsubishi warrants the lamp for one (1) year from the date of original purchase at retail. It is likely that the lamp will last much longer than this.

To Order a New Lamp

To Receive a Replacement Lamp Under Warranty

Call (800) 553-7278. Please have model number, serial number, and TV purchase date available.

Important: All lamps replaced under warranty must be returned to Mitsubishi where they will be inspected for defect verification.

To Purchase a Replacement Lamp After Warranty

Visit our website at www.mitsuparts.com or call (800) 553-7278. Order the following:

Lamp Part Number 915P061010

WARNING

- Do not remove the lamp cartridge immediately after turning off the television. You may get burned because the lamp is very hot. Allow the television to cool for at least one hour before replacing the lamp cartridge.
- Do not remove the lamp cartridge except when replacing it. Careless treatment can result in injury or fire.
- Do not touch the lamp glass element. It may be very hot and break, causing injuries or burns.
- Be sure not to insert any metal or flammable object into the lamp cartridge opening, as it may cause fire or electrical shock. If a foreign object is inserted into the opening, unplug the AC cord of the TV and contact your dealer for service.
- Install the lamp cartridge securely. Failure to do so may cause a fire.
- Do not touch the lamp glass elements. Oils from your fingers may cause premature lamp failure.

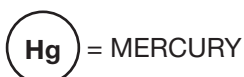

THE LAMP INSIDE THIS PRODUCT CONTAINS MERCURY AND MUST BE RECYCLED OR DISPOSED OF ACCORDING TO LOCAL, STATE OR FEDERAL LAWS. For disposal or recycling information, please contact your local authorities or the Electronic Industries Alliance at www.eiae.org

Appendix B: Lamp-Cartridge Replacement and Cleaning, continued

Lamp-Cartridge Replacement

Removing the Old Lamp Cartridge

1. Turn off TV power and allow the lamp to cool for at least one hour before proceeding.
2. After the lamp has cooled, remove the cover of the lamp compartment, located on the back of the TV. Refer to figures 1 and 2. Use a #2 (large) Phillips screwdriver to loosen the screw securing the cover. Keep the screw and cover for re-installation.
3. With a large Phillips or flat-blade screwdriver, loosen the two shiny screws securing the lamp cartridge until they disengage from the mating threads. These are captive screws and cannot be separated from the lamp cartridge.
4. Fully open the bag supplied with the replacement lamp and set the opened bag aside.
5. Gently grasp the handle of the lamp cartridge and pull the old cartridge straight out. See figure 3.

CAUTION: Do not tilt or rotate the cartridge, as small glass fragments may fall out.

6. Without tilting or putting down the lamp cartridge, insert it into the opened bag. Close the bag while being careful not to let any glass particles fall out.

Installing the New Lamp Cartridge

1. Do not touch the glass parts of the new lamp cartridge. Insert the new cartridge into the TV in the same orientation as the old cartridge. Push on the cartridge housing until it is fully seated.
2. With either your fingers or the screwdriver, gently tighten the two shiny screws. If using a screwdriver, **AVOID OVERTIGHTENING!**
3. Replace the plastic cover and retaining screws.
4. **WASH YOUR HANDS THOROUGHLY, AS THIS LAMP CONTAINS MERCURY.**

Disposal of the Old Lamp Cartridge

Lamp under warranty: All lamps replaced under warranty must be returned to Mitsubishi. Use the return shipping label provided and send to Mitsubishi Digital Electronics, America, 1001 Cherry Drive, Suite 2, Braselton, GA 30517.

IMPORTANT: Lamps found to be without defect will be returned and charged back to the sender.

Lamp no longer under warranty: Contact your local authorities or the Electronic Industries Alliance at www.eiae.org for lamp-disposal or recycling instructions. Do not dispose of the old lamp with common trash.

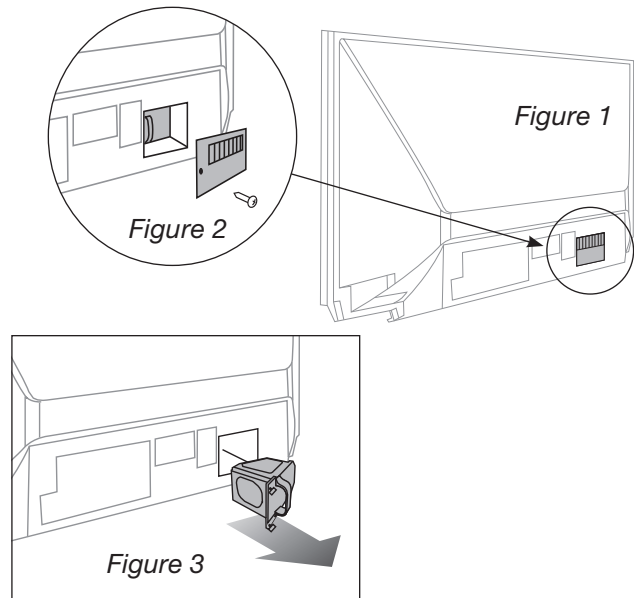

Use only replacement lamp part number 915P061010.

Lamp-Cartridge Filter Cleaning

If the TV shuts off after displaying the message “TV will shut down in a few seconds. Please check if the air flow is blocked ” and/or the STATUS LED is yellow, the air filter may need cleaning. The air filter is part of the lamp cartridge. Use the following procedure to clean the filter.

1. Remove the lamp cartridge from the TV as described under “Removing the Old Lamp Cartridge.” Do not tilt or rotate the cartridge. Do not touch the glass parts of the lamp cartridge.
2. Holding the lamp cartridge horizontal (do not tilt or rotate), use a soft dry brush or vacuum cleaner to remove any dust that may be present on the mesh filter. Do not use liquids. See figure 4.
3. Reinstall the lamp cartridge as described under “Installing the New Lamp Cartridge.”

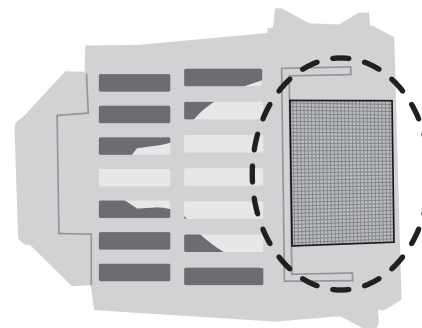

Figure 4
Keep lamp cartridge horizontal and remove dust from the mesh filter using a soft dry brush or vacuum cleaner.

Appendix C: Bypassing the Parental Lock

Lock Bypass Instructions Have Been Filed for Future Reference

IMPORTANT

Cut along the dotted line and file bypass instructions in a safe place for future reference.

Bypassing the Parental Lock

After you set the lock, you must use your pass code to view a locked program, view the locked TV, view a locked channel, cancel the lock, or enter the **Lock** menus.

If you forget your pass code, you can view the locked TV without entering your pass code. When you are prompted for your pass code, press the number **9** and **QV** keys on the TV remote control at the same time. This process temporarily unlocks the TV.

When entering the **Lock** menu, this process deletes your old pass code and prompts you to enter a new pass code.

- You can either enter a new pass code to open the **Lock** menu and make changes or press **EXIT** to close the menu.
- If any of the locks are turned on and you exit the menus when prompted for a new code, the old code and all lock settings are retained.
- If all locks are turned off and you exit the menus when prompted for a new code, then the previous code is erased.

IMPORTANT

When changing or deleting your pass code, you must use the remote control included with this TV. You cannot use a Mitsubishi remote control from another component or a “universal” remote.

This page intentionally left blank

Appendix D: Programming the Remote Control

This appendix explains programming the TV's remote control to operate other A/V devices. This is distinct from NetCommand control. The TV's remote control can operate other devices by three different methods:

- Remote Control Programming: You must move the slide switch to the position specific to the type of device.
- NetCommand® IR "learning": You can operate other devices with the slide switch in the TV position.
- NetCommand for HDMI devices (all TV models): You may be able to operate compatible HDMI devices with the slide switch in the TV position. See the device's Owner's Guide and the description in chapter 4, "TV Operation and Features."

Functions Available for Other A/V Devices

The TV's remote control can be programmed to operate other types and brands of A/V products. To use the remote when programmed, **set the slide switch to the position labelled for the product type**. The functions performed in each switch position can vary depending on the product. Not all functions work for all models. The most common functions available are listed on this page.

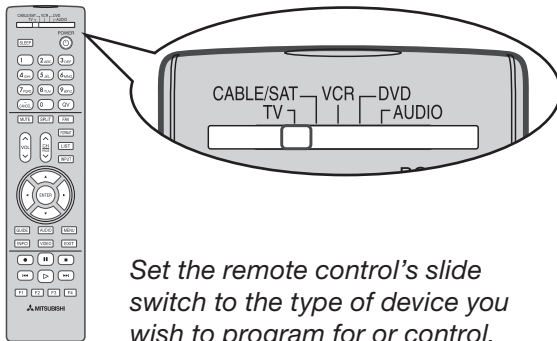

Set the remote control's slide switch to the type of device you wish to program for or control.

IMPORTANT

Some manufacturers may change their products or they may use more than one remote control system. The TV's remote control may be unable to operate your A/V equipment in these cases.

VCRs and DVRs	
<ul style="list-style-type: none"> • CH \wedge/\vee • POWER • SLEEP • \blacktriangleright (FAST FORWARD) • \parallel (PAUSE) • \blacktriangleright (PLAY) 	<ul style="list-style-type: none"> • \bullet (RECORD) • \blacktriangleleft (REVERSE) • \blacksquare (STOP) • GUIDE (DVR only) • MENU (DVR only) • 0-9 Number Buttons

Mitsubishi VCRs are compatible with some additional buttons.

Cable Boxes and Satellite Receivers	
<ul style="list-style-type: none"> • AUDIO (PAGE UP) • CANCEL (on some models) • CH \wedge/\vee • ENTER (on some models) • GUIDE (on some models) • LIST • POWER • $\blacktriangle\blacktriangledown\blacktriangleleft\blacktriangleright$ (on some models) • VIDEO (PAGE DOWN) • QV (ENTER; for channels on some models) 	<ul style="list-style-type: none"> • 0-9 Number Buttons (on some models) • F1-F4 (A, B, C, D keys on some models) <p>The record/playback keys (on some models):</p> <ul style="list-style-type: none"> • \blacktriangleright (FAST FORWARD) • \parallel (PAUSE) • \blacktriangleright (PLAY) • \bullet (RECORD) • \blacktriangleleft (REVERSE) • \blacksquare (STOP)

A/V Receivers	
<ul style="list-style-type: none"> • MUTE • POWER • SLEEP • VOLUME • 0-9 Number Buttons 	<ul style="list-style-type: none"> • Direct Input Selection buttons: numbers, FAV and QV (on some Mitsubishi models)

CD Players	
(not all functions for all models)	
<ul style="list-style-type: none"> • SLEEP • \blacktriangleright (FAST FORWARD) • \parallel (PAUSE) • \blacktriangleright (PLAY) 	<ul style="list-style-type: none"> • \blacktriangleleft (REVERSE) • \blacksquare (STOP) • 0-9 Number Buttons



DVD and Laser Disc Players	
(not all functions for all models)	
<ul style="list-style-type: none"> • CANCEL (on some models) • CH \wedge/\vee (for track skip on some models) • ENTER • MENU • POWER • SLEEP • $\blacktriangle\blacktriangledown\blacktriangleleft\blacktriangleright$ (on some models) 	<ul style="list-style-type: none"> • \blacktriangleright (FAST FORWARD) • \parallel (PAUSE) • \blacktriangleright (PLAY) • \bullet (RECORD) • \blacktriangleleft (REVERSE) • \blacksquare (STOP) • 0-9 Number Buttons (on some models)

Appendix D: Programming the Remote Control, continued

Programming the Remote Control

1. Move the slide switch at the top of the remote to the position for the product you want to control. Refer to the table below. Only one of each device type can be controlled in each slide-switch position.

Switch Position	Affected Device
CABLE/SAT	Cable Box DTV Receiver Satellite Receiver
VCR	VCR DVR Laser Disc Player DVD Player/Recorder
DVD	DVD Player/Recorder DVR Laser Disc Player VCR
AUDIO	A/V Receiver Audio Amplifier CD Player

2. Press and hold **POWER** on the remote control for several seconds until the button blinks twice and goes off.
3. Release the **POWER** button.
4. Enter the first five-digit code listed for your equipment.
 - The **POWER** button blinks twice when you start to enter the code and then once for each additional keypress.
 - The **POWER** button blinks twice when you finish entering a valid code.
 - Move the slide switch to another position if you need to start over or wish to exit programming mode.
5. Point the remote control at the equipment and press **POWER**. If the product has no power on/off function, press a different key, such as  (**PLAY**),  (**STOP**), **VOL** , or **MUTE**.
 - If the equipment responds, the remote control is properly programmed to operate the equipment.
 - If the equipment does not respond, repeat steps 2–4 with the next five-digit code listed for your equipment.

6. Once you have found the correct code, write it in the space below for future reference.

Switch Position	Device Type	Code
CABLE/SAT		
VCR		
DVD		
AUDIO		

Code Verification

To determine the code programmed for any position of the slide switch:

1. Move the slide switch to the position you wish to verify.
2. Press and hold **POWER** on the remote control for several seconds until the button blinks twice and goes off.
3. Press keys **9 9 0**
4. Press **1** and count the blinks of the power button. Write down the number of blinks as the first digit of the code.
5. Repeat step 4 for the second, third, fourth, and fifth digits of the code.

Audio Lock: Universal A/V Receiver Control

With Audio Lock active, the remote control operates the volume and mute functions of the A/V receiver in all positions of the slide switch. Activate Audio Lock if you normally use an A/V receiver with your TV and other A/V equipment.

1. Program the **AUDIO** position for your A/V receiver as described earlier in this section.
2. Move the slide switch to the **AUDIO** position.
3. Press and hold **POWER** on the remote control for several seconds until the button blinks twice and goes off.
4. Press keys **9 9 3 ENTER**
The **POWER** button will blink twice to indicate Audio Lock is active.

To Reset the Remote Control to Operate Volume and Mute for the TV Speakers

1. Press and hold **POWER** for several seconds until the key blinks twice and goes off.
 2. Press keys **9 9 3 VOL** .
- The **POWER** key will blink four times to indicate Audio Lock has cleared.

IMPORTANT

You may need to reprogram the remote control after changing the batteries.

Appendix D: Programming the Remote Control, continued

Programming Codes

Audio Amplifiers	
Brand	Code
Acurus	30765
Adcom	31100, 30577
Altec Lansing	31742
Aragon	30765
Bel Canto Design	31583
Bose	30674
Carver	30892
Classe	31462, 31461
Curtis Mathes	30300
Durabrand	31561
Elan	30647
GE	30078
Harman/Kardon	30892
JVC	30331
Klipsch	30765
Left Coast	30892
Lenoxx	31561
Lexicon	31802
Logitech	31408
Marantz	30892
Mark Levinson	31483
McIntosh	30251
Mondial	30765
Optimus	30823, 30395, 30300
Philips	30892
Pioneer	30823, 30300, 30257, 30013
Polk Audio	30892
RCA	30823, 30300
Realistic	30395
Sharp	30226
Sony	30815
Soundesign	30078
Technics	30374, 30372
Toshiba	30353
Victor	30331
Wards	30078, 30013
Yamaha	30354

A/V Receivers	
Brand	Code
ADC	30531
Adcom	31617, 31616
Aiwa	31641, 31405, 31388, 31347, 31321, 31243, 30189, 30121
Akai	31255
Alco	31390
AMC	31077
Amplifier Technologies	31584
Anam	31609, 31074
Apex Digital	31774, 31430, 31257
Arcam	31189

A/V Receivers	
Brand	Code
Atlantic Technology	31487
Audiophase	31387
Audiotronic	31189
Audiovox	31627, 31390
B & K	30840, 30820, 30701
Bel Canto Design	31584
BK	30702
Bose	31253, 31229, 30639
Brix	31602
Cambridge Soundworks	31477
Capetronic	30531
Carver	31289, 31189, 30189, 30121
Coby	31263
Curtis	30797
Delphi	31414
Denon	31360, 31311, 31142, 30121,
Fisher	31801, 31409
Fosgate	31487
Glory Horse	31263
GPX	31299
Harman/Kardon	31306, 31304, 31289, 30891, 30189, 30110
Hitachi	31801, 31273
Integra	31320, 31298, 30135
JBL	31306, 30110
JVC	31811, 31643, 31495, 31374, 31282, 31263, 31058
Kenwood	31570, 31569, 31313
KLH	31428, 31390
Koss	31497, 31366
Linn	30189
Liquid Video	31497
Magnavox	31514, 31269, 31189, 30531, 30189
Marantz	31289, 31269, 31189, 30200, 30189,
McIntosh	31289
Micromega	31189
Mitsubishi	31957, 31922, 31921, 31920, 31393, 30176
Myryad	31189
Nakamichi	31555, 31313, 30097
Onkyo	31320, 31298, 30842, 30135
Optimus	31074, 31023, 30849, 30797, 30670, 30531
Oritron	31497, 31366
Outlaw	31487

A/V Receivers	
Brand	Code
Panasonic	31764, 31763, 31633, 31548, 31518, 31509, 31363, 31350, 31316, 31308, 31288, 30309
Philips	31368, 31365, 31283, 31269, 31268, 31266, 31189, 30189
Pioneer	31384, 31343, 31023, 30630, 30531, 30150, 30014
Polk Audio	31414, 31289, 30189
Proscan	31254
RadioShack	31263
RCA	31609, 31511, 31390, 31254, 31074, 31023, 30531
Rio	31869
Samsung	31500, 31295
Sansui	31189, 30189
Sanyo	31801
Sharp	31386, 31361
Sharper Image	31416, 31411, 31410, 31409, 31385, 31263, 30797
Sherwood	31077
Sirius	31811, 31627, 31602
Sonic Blue	31869
Sony	31858, 31759, 31758, 31658, 31622, 31558, 31529, 31503, 31458, 31441, 31406, 31382, 31371, 31367, 31258, 31131, 31058
Soundesign	30670
Stereophonics	31023
Sunfire	31313
Sylvania	30797
Teac	31528, 31390, 31267, 31074
Technics	31633, 31518, 31308, 30309
Thorens	31189
Toshiba	30135
Venturer	31390, 30849
Wards	30189, 30014
XM	31414, 31406
Yamaha	31375, 31331, 31276, 31176, 30176

Appendix D: Programming the Remote Control, continued

Programming Codes, continued

CD Players	
Brand	Code
Aiwa	30157
Akai	30156
Arcam	30157
Audio-Technica	30170
Burmester	30420
California Audio Labs	30303, 30029
Carver	30437, 30299, 30179, 30157
Classic	31297
Denon	30873, 30034, 30003
DKK	30000
DMX Electronics	30157
Emerson	30305
Fisher	31325, 30179, 30174
Garrard	30420, 30393
Gemini	30625
Genexxa	30305, 30032
GPX	31296
Harman/Kardon	31202, 30173, 30157, 30083
Hitachi	30032
Integra	30101
JVC	31294, 30072
Kenwood	30826, 30681, 30626, 30190, 30037, 30028,
KLH	31711, 31373, 31372, 31318
Koss	31317
Krell	30157
LG	31208
Linn	30157
LXI	30305
Magnavox	30305, 30157, 30038
Marantz	30626, 30435, 30180, 30157, 30038, 30029
Mark Levinson	31484
McIntosh	30660, 30290, 30256
MCS	30029
MGA	30083
Miro	30000
Mission	30157
Mitsubishi	30098, 30083
MTC	30625, 30420
NAD	30299, 30019
Nikko	30625, 30174, 30170
NSM	30157
Onkyo	31327, 30868, 30102, 30101

CD Players	
Brand	Code
Optimus	31075, 31063, 30468, 30437, 30420, 30305, 30179, 30145, 30087, 30037, 30032, 30000
Panasonic	30752, 30388, 30303, 30029
Parasound	30420
Philips	30626, 30274, 30157
Pioneer	31087, 31063, 31062, 30551, 30468, 30305, 30032
Polk Audio	30157
Proceed	30420
Proton	30157
QED	30157
Quad	30157
Quasar	30029
RadioShack	31075
RCA	31062, 30764, 30468, 30420, 30305, 30179, 30053, 30032
Realistic	30420, 30180, 30179
Rotel	30420, 30157
SAE	30157
Sansui	30305, 30157
Sanyo	30179, 30087
Scott	30305
Sears	30305
Sharp	30861, 30265, 30180, 30037
Sherwood	31067, 30180
Sonic Frontiers	30157
Sony	31364, 30673, 30605, 30604, 30490, 30185, 30100, 30000
Soundesign	30145
Sugden	30157
Symphonic	30305
TAG McLaren	30157
Tascam	30420
TDK	31208
Teac	30420, 30393, 30378, 30180, 30174
Technics	30303, 30029
Tivoli Audio	31553
Toshiba	30299, 30019
Victor	30072
Wards	30157, 30053
Yamaha	31292, 30888, 30490, 30261, 30187, 30170, 30036,
YBA	30625
Yorx	30461

Cable Boxes	
Brand	Code
ABC	10017, 10014, 10013, 10011, 10008, 10007, 10003, 10001
Allegro	10315, 10153
Americast	10899
Antronix	10207, 10022
Archer	10797, 10207, 10153, 10022
BBT	10267
Belcor	10056
Bell & Howell	10014
Bell South	10899
Cable Star	10056
Cabletenna	10022
Cableview	10022
Century	10153
Citizen	10315, 10153
Clearmaster	10883
ClearMax	10883
Colour Voice	10031, 10025
Comtronics	10040
Contec	10019
Coolmax	10883
Digeo	11187
Digi	10637
Director	10476
Dumont	10637
Eastern	10002
Emerson	10797
Everquest	10040, 10015
Focus	10400
Garrard	10153
GC Electronics	10207, 10056
Gemini	10797, 10015
General Instru-ment	10810, 10476, 10276, 10011, 10003
GoldStar	10144, 10040
Goodmind	10797
Hamlin	10273, 10259, 10034, 10020, 10009
Hitachi	10011
Hytex	10007
i3 Micro	11602
Jasco	10315, 10153, 10015
Jerrold	10810, 10476, 10276, 10024, 10015, 10014, 10012, 10011, 10003
Linsay	10440
Magnavox	10027
Memorex	10000
Motorola	11376, 11254, 11187, 11106, 10810, 10476, 10276, 10014
Movie Time	10156, 10063
Multitech	10883
Myrio	11602
Novaplex	10618
NSC	10156, 10063
Oak	10019, 10007

Appendix D: Programming the Remote Control, continued

Programming Codes, continued

Cable Boxes	
Brand	Code
Optimus	10021
Pace	11877, 10237, 10008
Panasonic	10107, 10021, 10000
Panther	10637
Paragon	10000
Philips	11305, 10317, 10153, 10031, 10027, 10025
Pioneer	11877, 10877, 10533, 10144, 10023
Popular Mechanics	10400
Pulsar	10000
Quasar	10000
RadioShack	10883, 10797, 10315, 10015
RCA	11256, 10021
Realistic	10207
Recoton	10400
Regal	10279, 10273, 10259, 10020
Regency	10002
Rembrandt	10011
Runco	10000
Samsung	10144, 10040
Scientific Atlanta	11877, 10877, 10477, 10017, 10008,
Seam	10510
Sejin	11602
Signal	10040, 10015
Signature	10011
SL Marx	10040
Sony	11006
Sprucer	10021
Starcom	10015, 10003
Stargate	10797, 10040, 10015
Starquest	10015
StarSight	10422
Supercable	10276
Supermax	10883
Sylvania	10001
Tandy	10258
TeleCaption	10221
Televue	10040
Texscan	10001
TFC	10310
Thomson	11256
Timeless	10418, 10040
Tocom	10013, 10012
Torx	10003
Toshiba	10000
Tristar	10883
Tusa	10015
TV86	10063
Unika	10207, 10153, 10022
United Artists	10007
Universal	10207, 10191, 10153, 10056, 10022,
V2	10883
Viewmaster	10883
Viewstar	10258, 10063, 10027

Cable Boxes	
Brand	Code
Vision	10883
Vortex View	10883
Zenith	10899, 10525, 10054, 10000
Zentek	10400

DVD Players/Recorders	
Brand	Code
Adcom	21094
Aiwa	20641
Akai	21089, 20770
Alco	20790
Allegro	20869
Amphion Media Works	20872
AMW	20872
Apex Digital	21100, 21061, 21056, 21020, 21004, 20797, 20796, 20794, 20755, 20717, 20672
Aspire Digital	21407, 21168
Audiologic	20736
Audiovox	21072, 21041, 20790
Axion	21072
B & K	20662, 20655
Bel Canto Design	21571
Blaupunkt	20717
Blue Parade	20571
Broksonic	20695
California Audio Labs	20490
CAVS	21057
Cinea	20831
CineVision	20876, 20869, 20833
Citizen	21277
Coby	21351, 21177, 21165, 21107, 21086, 20852, 20778
Craig	20831
Curtis Mathes	21087
CyberHome	21129, 21117, 21024, 21023, 20874, 20816
Daewoo	21242, 21234, 21172, 21169, 20869, 20833, 20784, 20705
Daytek	20872
Denon	20634, 20490
Desay	21407
Disney	21270, 20675
Dual	21085, 21068
Durabrand	21127
DVD2000	20521
Emerson	21268, 20675, 20591
Enterprise	20591
Fisher	20670

DVD Players/Recorders	
Brand	Code
Funai	21334, 21268, 20675
Gateway	21158, 21077, 21073
GE	20815, 20717, 20522
Go Video	21730, 21304, 21158, 21144, 21099, 21075, 21044, 20869, 20833, 20783, 20744, 20741, 20715
Go Vision	21072
GoldStar	20741
GPX	20769, 20699
Gradiente	20490
Greenhill	20717
Grundig	20539
Harman/Kardon	20702, 20582
Hitachi	20664, 20573
Hiteker	20672
iLo	21348
Initial	20717
Integra	20627, 20571
Jaton	21078
JBL	20702
JSI	21423
JVC	21275, 21164, 20867, 20623, 20558
jWin	21051, 21049
Kawasaki	20790
Kenwood	20737, 20682, 20534, 20490
KLH	21149, 21020, 20790, 20717
Konka	20721, 20711
Koss	21423, 20896, 20651
Landel	20826
Lasonic	21173, 20798
Lecson	21533
Lenoxx	21127
LG	20869, 20801, 20741, 20591
LiteOn	21440, 21416, 21158, 21058
Loewe	20511
Magnavox	20675, 20646, 20539, 20503
Malata	21159, 20782
Marantz	20539
McIntosh	21533, 21273
Memorex	21270, 20831, 20695
Microsoft	20522
Mintek	20839, 20717
Mitsubishi	21521, 20521
Momitsu	21082
Myryad	20894
NAD	20741, 20692, 20591
Nakamichi	21222

Appendix D: Programming the Remote Control, continued

Programming Codes, continued

DVD Players/Recorders	
Brand	Code
NEC	20785
Nesa	20717
Next Base	20826
NexxTech	21402
Norcent	21265, 21107, 21003, 20872
Onkyo	20792, 20627, 20503
OptoMedia Elec- tronics	20896
Oritron	20651
Panasonic	21762, 20703, 20632, 20503, 20490
Philips	21354, 21267, 20675, 20646, 20539, 20503,
PianoDisc	21024
Pioneer	21571, 20632, 20631, 20571, 20525
Polaroid	21086, 21061, 21020
Polk Audio	20539
Portland	20770
Princeton	20674
Proceed	20672
Proscan	20522
ProVision	20778
Qwestar	20651
RCA	20822, 20790, 20717, 20571, 20522
Rio	20869
RJTech	21360
Rotel	21178, 20623
Rowa	20823
Sampo	20752, 20698
Samsung	21075, 21044, 20820, 20744, 20573, 20490
Sansui	20695
Sanyo	20873, 20695, 20670
Sensory Science	21158
Sharp	21256, 20752, 20675, 20630
Sharper Image	21117
Sherwood	21077, 21043, 20770, 20633
Shinsonic	20839, 20533
Sigma Designs	20674
Sonic Blue	21099, 20869
Sony	21533, 21431, 21033, 20864, 20533
Sungale	21074
SVA	21105, 20860
Sylvania	21268, 20675
Symphonic	21268, 20675
TAG McLaren	20894
Teac	20809, 20790
Technics	20703, 20490

DVD Players/Recorders	
Brand	Code
Technosonic	20730
Techwood	20692
Terapin	21031
Theta Digital	20571
Toshiba	21154, 20695, 20503
Tredex	20804, 20803, 20800, 20799
Urban Concepts	20503
US Logic	20839
Venturer	20790
Vizio	21226, 21064
Vocopro	21027
Xbox	20522
Xwave	21001
Yamaha	20545, 20539, 20490
Yamakawa	20872
Zenith	20869, 20741, 20591, 20503
Zoece	21265

Laser Disc Players	
Brand	Code
Aiwa	20203
Carver	20323, 20194, 20064
Denon	20243, 20241, 20172, 20059
Disco Vision	20023
Funai	20203
Harman/Kardon	20194
Hitachi	20023
Kenwood	20258
Magnavox	20243, 20241, 20217, 20194 20194, 20064
Marantz	20059
Mitsubishi	20059
NAD	20059
Optimus	20059
Panasonic	20204
Philips	20194, 20064
Pioneer	20059, 20023
Polk Audio	20194
Quasar	20204
Realistic	20203
Samsung	20323
Sega	20023
Sony	20270, 20201, 20193
Technics	20204
Theta Digital	20194
Yamaha	20451, 20217

Satellite Receivers	
Brand	Code
AlphaStar	10772
Chaparral	10216
Crossdigital	11109
DirecTV	11856, 11749, 11640, 11639, 11609, 11444, 11443, 11442, 11414, 11392, 11377, 11142, 11109, 11108, 11076, 10819, 10749, 10724, 10639, 10566, 10392, 10247, 10099
Dish Network System	11775, 11505, 11170, 11005, 10775,
Dishpro	11775, 11505, 11005, 10775
Echostar	11775, 11505, 11170, 11005, 10775
Expressvu	11775, 10775
GE	10566, 10392
General Instru- ment	10869
GOI	11775, 10775
Goodmans	11246
Hisense	11535
Hitachi	11250, 10819
HTS	11775, 10775
Hughes Network Systems	11749, 11444, 11443, 11442, 11142, 10749
iLo	11535
Jerrold	10869
JVC	11775, 11170, 10775
LG	11414, 11226
Magnavox	10724, 10722
Memorex	10724
Mitsubishi	10749
Motorola	10869, 10856
NEC	11270
Next Level	10869
Panasonic	10701, 10247
Paysat	10724
Philips	11749, 11442, 11142, 11076, 10819, 10749, 10724, 10722, 10099
Pioneer	11442
Proscan	10566, 10392
Proton	11535
RadioShack	10869
RCA	11392, 10855, 10566, 10392, 10143,
Samsung	11609, 11442, 11377, 11276, 11142, 11109, 11108
Sanyo	11219
Sony	11640, 11639, 10639
Star Choice	10869
Tivo	11444, 11443, 11442, 11142

Appendix D: Programming the Remote Control, continued

Programming Codes, continued

Satellite Receivers	
Brand	Code
Toshiba	11749, 11285, 10819, 10790, 10749
UltimateTV	11640, 11392
Uniden	10724, 10722
US Digital	11535
USDTV	11535
Voom	10869
Zenith	11856

VCRs and DVRs	
Brand	Code
ABS	21972
Admiral	20479, 20209, 20048
Adventura	20000
Aiko	20278
Aiwa	20307, 20124, 20037, 20000
Akai	20242, 20175, 20106, 20061, 20041
Alienware	21972
America Action	20278
American High	20035
Asha	20240
Audiovox	20278, 20037
Beaumarck	20240
Bell & Howell	20104
Broksonic	20479, 20295, 20209, 20184, 20121, 20002
Calix	20037
Canon	20035
Capehart	20020
Carver	20081
CCE	20278, 20072
Citizen	20278, 20037
Colt	20072
Craig	20271, 20240, 20072, 20047, 20037
Curtis Mathes	20760, 20162, 20060, 20041, 20035
Cybernex	20240
CyberPower	21972
Daewoo	20637, 20561, 20278, 20045, 20020
Daytron	20020
Dell	21972
Denon	20042
DirectTV	20739
Durabrand	20039, 20038
Dynatech	20000
Electrohome	20043, 20037
Electrohome	20037
Emerex	20032

VCRs and DVRs	
Brand	Code
Emerson	21593, 20637, 20593, 20561, 20479, 20295, 20278, 20212, 20209, 20208, 20184, 20121, 20068, 20061, 20043, 20037, 20036, 20002, 20000
Fisher	20104, 20066, 20054, 20047
Fuji	20035, 20033
Funai	21593, 20593, 20000
Garrard	20000
Gateway	21972
GE	20761, 20760, 20240, 20202, 20060, 20035
Go Video	20643, 20526, 20432, 20240
GoldStar	20038, 20037
Gradiente	20000
Harley Davidson	20000
Harman/Kardon	20081, 20075, 20038
Harwood	20072, 20068
Headquarter	20046
Hewlett Packard	21972
HI-Q	20047
Hitachi	20105, 20089, 20042, 20041, 20000
Howard Computers	21972
HP	21972
Hughes Network Systems	20739, 20042
Humax	20739
Hush	21972
iBUYPOWER	21972
Jensen	20041
JVC	21162, 20067, 20041, 20008
KEC	20278, 20037
Kenwood	20067, 20041, 20038
KLH	20072
Kodak	20037, 20035
LG	21037
Linksys	21972
Lloyd's	20208, 20000
Logik	20072
LXI	20037
Magnasonic	20593
Magnavox	20593, 20563, 20149, 20110, 20081, 20039, 20035, 20000
Magnin	20240
Marantz	20081, 20035

VCRs and DVRs	
Brand	Code
Marta	20037
Matsushita	21162, 20162, 20035
Media Center PC	21972
MEI	20035
Memorex	21262, 21162, 21037, 20479, 20307, 20240, 20209, 20162, 20104, 20048, 20047, 20046, 20039, 20037, 20035, 20000
MGA	20240, 20061, 20043
MGN Technology	20240
Microsoft	21972
Mind	21972
Minolta	20105, 20042
Mitsubishi	20443, 20242, 20214, 20173, 20075, 20067, 20061, 20043
Motorola	20048, 20035
MTC	20240, 20000
Multitech	20072, 20000
NEC	20104, 20067, 20041, 20040, 20038
Nikko	20037
Nikon	20034
Niveus Media	21972
Noblex	20240
Northgate	21972
Olympus	20035
Onkyo	20222
Optimus	21262, 21162, 21062, 21048, 20593, 20432, 20162, 20104, 20048, 20037
Optonica	20062
Orion	20479, 20295, 20209, 20184, 20002
Panasonic	21262, 21162, 21062, 20616, 20225, 20162, 20077, 20035
Penney	20240, 20054, 20042, 20040, 20038, 20037, 20035
Pentax	20105, 20042
Philco	20035
Philips	21181, 21081, 20739, 20618, 20110, 20081, 20062, 20035
Pilot	20037

Appendix D: Programming the Remote Control, continued

Programming Codes, continued

VCRs and DVRs	
Brand	Code
Pioneer	20067
Polk Audio	20081
Portland	2020
Profitronic	20240
Proscan	20761, 20760, 20202, 20060
Protec	20072
Pulsar	20039
Quarter	20046
Quartz	20046
Quasar	21162, 20162, 20077, 20035
RadioShack	21037, 20000
Radix	20037
Randex	20037
RCA	20880, 20761, 20760, 20240, 20202, 20149, 20106, 20105, 20077, 20060, 20042
Realistic	20104, 20066, 20062, 20048, 20047, 20046, 20037, 20035, 20000
ReplayTV	20616, 20614
Ricavision	21972
Ricoh	20034
Runco	20039
Salora	20075
Samsung	20739, 20240, 20045
Samtron	20643
Sanky	20048, 20039
Sansui	20479, 20271, 20209, 20067, 20041, 20000
Sanyo	20240, 20159, 20104, 20047, 20046
Scott	20212, 20210, 20184, 20121, 20045, 20043
Sears	20105, 20104, 20066, 20054, 20047, 20046, 20042, 20037, 20035, 20000
Sharp	20848, 20062, 20048
Shintom	20072
Shogun	20240
Singer	20072
Sonic Blue	20616, 20614
Sony	21972, 21032, 20636, 20035, 20034, 20033, 20032, 20000
Stack 9	21972
STS	20042

VCRs and DVRs	
Brand	Code
Sylvania	21593, 20593, 20110, 20081, 20043, 20035, 20000
Symphonic	21593, 20593, 20000
Systemax	21972
Tagar Systems	21972
Tatung	20041
Teac	20041, 20000
Technics	20162, 20035
Teknika	20037, 20035, 20000
Thomas	20000
Tivo	21503, 20739, 20636, 20618
TMK	20240, 20208, 20036
Toshiba	21972, 21503, 21008, 20212, 20210, 20209, 20066, 20045, 20043
Totevision	20240, 20037
Touch	21972
Unitech	20240
Vector	20045
Vector Research	20040, 20038
Video Concepts	20061, 20045, 20040
Videomagic	20037
Videosonic	20240
Viewsonic	21972
Villain	20000
Voodoo	21972
Wards	20760, 20240, 20212, 20149, 20081, 20072, 20062, 20060, 20048, 20047, 20042, 20035, 20000
White Westinghouse	20637, 20209, 20072
XR-1000	20072, 20035, 20000
Yamaha	20038
Zenith	21139, 20637, 20479, 20209, 20039, 20034, 20033, 20000
ZT Group	21972

Appendix E: Troubleshooting

TV Reset Comparison Guide

You can resolve many common TV problems using the reset functions described in the following table. See also the troubleshooting suggestions later in this appendix.

IMPORTANT

Before you change sound or picture settings: If picture or sound settings seem wrong for a broadcast

channel (a channel from **ANT 1**, **ANT 2**, a cable box, or satellite receiver), first check other channels from the same input before changing settings. If most other channels from the same input seem correct, there is likely a problem with the broadcast rather than with the TV. Use care in this case, as changes you make to fix problems on individual channels also affect all other channels on the same input.

Reset Name	When to Use	How to Use	Resulting Action
Format	When the picture shape seems incorrect, use FORMAT to change the shape of the picture.	Press the FORMAT key to cycle through the available formats to find the best format for the current picture.	The last-used format for a signal type is memorized for each input. The next time the same input and the same signal type is viewed, the last-used format will be recalled.
PerfectColor™ and PerfectTint™ Reset (for the single input currently being watched)	When the color intensities seem out of balance, use the PerfectColor/PerfectTint reset to reset the color balances to the original factory settings. Both PerfectColor and PerfectTint are reset at the same time.	<ol style="list-style-type: none"> While viewing the input to be reset, press MENU to display the Main menu with the A/V icon highlighted. Use ▶ to highlight PerfectColor and press ENTER to display the PerfectColor adjustment screen. Press CANCEL to reset the colors. 	All PerfectColor/PerfectTint sliders are reset to the original center position. The PerfectColor/PerfectTint settings for other inputs remain unchanged.
A/V Memory Reset (for the single input currently being watched)	When audio and/or video settings for a single input seem incorrect, use A/V Memory Reset to return the input to the original factory settings.	<ol style="list-style-type: none"> While viewing the input to be reset, press MENU to display the Main menu with the A/V icon highlighted. Use ▶ to highlight the Reset icon and press ENTER to reset. 	All Audio and Video settings for the individual input are reset except for the Listen To, Language, audio Balance, and Closed Caption settings.
A/V Reset (for all inputs)	To reset audio and video adjustments for all inputs to the original factory settings.	While viewing the TV, press the front panel buttons GUIDE and FORMAT at the same time.	All Audio and Video settings are returned to the original factory settings, including Listen To and Language, plus Closed Captions settings and Format settings .
Channel Memorization	To erase and re-memorize channels on ANT 1 or ANT 2 .	<ol style="list-style-type: none"> While viewing the TV, press MENU to display the Main menu. Press ▼ to highlight the Setup icon. Press ▶ to highlight the Scan icon. Press ▼ to highlight the antenna input and reception mode, e.g. Ant 1 Air. Press ▶ to highlight the Start button icon and press ENTER to start the memorization. 	All previously memorized channels for the selected antenna input are erased and a new set of memorized channels is created. All custom settings for Fav, channel names, and channel locks are deleted. To add or delete individual channels, see Edit menu instructions in chapter 5, "TV Menu Settings."
Lock Menu Pass Code	To change your Lock menu pass code	See the cutout page in Appendix C.	Allows a new code to be established.

Appendix E: Troubleshooting, continued

Reset Name	When to Use	How to Use	Resulting Action
Front-Panel Lock Release	To re-enable the front-panel controls after activation of the Front-Panel Lock	<ul style="list-style-type: none"> When Energy Mode is set to Fast Power On, press and hold the MENU button on the front panel for over eight seconds. When Energy Mode is set to Low Power, press POWER on the front panel to turn on the TV. Press and hold the MENU button on the front panel for over eight seconds. 	Allows the front panel to be unlocked if the remote control is misplaced.
System Reset	If the TV does not turn on or off, does not respond to the remote control or front panel buttons, or has audio but no video.	Press the SYSTEM RESET button on the front panel with a pointed object such as the point of pencil or end tip of a paperclip.	The TV will turn off and the green LED will flash quickly for about one minute. When the green LED stops flashing, you may turn on the TV. The changes you made most recently, before using SYSTEM RESET , may be lost. Changes you made previously, however, are not lost.
TV Reset IMPORTANT: Use this reset only if all other resets have been unsuccessful.	To reset all consumer-accessible settings and all memories to the original factory defaults. CAUTION: All owner-performed setups and adjustments will be erased.	<ol style="list-style-type: none"> While viewing the TV, press MENU to display the TV Main menu. With the Main menu displayed, press number keys 1 2 3 to display the Reset menu. READ THE ON-SCREEN WARNING AND INSTRUCTIONS. <ul style="list-style-type: none"> If you do not wish to use this reset, press EXIT or MENU to back out. If you do wish to use the reset, press ENTER to erase all memories and settings. 	The TV will start the initialization process. The TV will then turn off and the front green LED will start flashing. When the LED stops flashing, you can turn the TV on again. The Parental Lock Pass code will remain unaffected, but all other memories and settings outlined in this Owner's Guide will need to be set again.

Service and Support

Service

If you are unable to correct a problem with your TV, consult your Mitsubishi dealer or Mitsubishi Consumer Relations at (800) 332-2119.

- DO NOT adjust any controls other than those described in this Owner's Guide.
- DO NOT remove the protective back cover of your TV.

Support

- To order replacement or additional remote controls, lamp cartridges, or Owner's Guides,

visit our website at www.mitsuparts.com or call (800) 553-7278.

- For questions:
 - Call Consumer Relations at 800-332-2119.
 - E-mail: MDEAservice@mdea.com
 - Website: www.mitsubishi-tv.com

Important

All lamps replaced under warranty must be returned to Mitsubishi where they will be inspected for defect verification.

Appendix E: Troubleshooting, continued

General TV Operation		
	Symptom	Remarks
1.	A fan is running even while the TV is powered off.	The room is too warm. When the TV is off, internal components continue to draw power and must be cooled by the fan.
2.	The TV remote control does not work.	<ul style="list-style-type: none"> • Check that the batteries are fresh and installed correctly. • Check that the slide switch on the remote is set to TV. • Be no more than 20 feet from the TV when using the remote control. • Program the remote control to operate the TV or other device. • Reset the remote control.
3.	When I try to use the remote control, the POWER key blinks five times.	Replace the batteries.
4.	TV does not respond to the remote control or to front panel control and TV will not power on or off.	Use the System Reset button.
5.	When a device is selected from the Input Selection menu, the screen is blue (no signal source).	<ul style="list-style-type: none"> • Make sure the selected device is turned on. • Begin play of the VCR.
6.	You have forgotten your Lock menu pass code.	See Appendix C, Bypassing the Parental Lock.
7.	Rating restrictions are not working.	Open the Parental Lock menu and: <ul style="list-style-type: none"> • Verify that the U.S. Ratings or Other Ratings setting is On. • Check the Lock Time/Unlock Time to check if rating restrictions are disabled. • Rating restrictions apply only to content on ANT 1 and ANT 2, INPUT 1–3, IEEE 1394 A/V disc and DVCR.
8.	On-screen displays appear each time you change a function.	Normal TV operation.
9.	A warning message appeared on screen stating, “TV will shut down in a few seconds. Please check if the air flow is blocked.”	<ul style="list-style-type: none"> • Room temperature has exceeded proper levels. Cool the room. • The TV has overheated. Clear blocked air vents and ensure at least four inches of clearance on all sides of the TV. • Clean the air filter on the lamp cartridge.

TV Channels		
	Symptom	Remarks
1.	The TV takes several seconds to respond to channel changes.	<ul style="list-style-type: none"> • It is normal for digital channels to take longer to tune in. • Press ENTER after entering channel number to avoid delays. • Use a 4-digit number for an over-the-air digital channel. • Use a 6-digit number for digital cable channels if your cable service is able to recognize 6-digit channel numbers.
2.	You cannot access a channel.	<ul style="list-style-type: none"> • Use number keys instead of CH \wedge/\vee. • Be sure the channel you want to view is in memory. See Setup > Scan in chapter 5, “TV Menu Settings.” • Check that the TV is switched to the correct device or antenna for that channel by pressing the INPUT button. • Make sure Channel Lock is off. • Make sure the Lock > Parent menu lock is set to off. • If you cannot tune to a virtual digital channel even though the TV has already memorized digital channels, tune to the physical channel number used by the broadcaster. The virtual channel will then be automatically added to memory.

Appendix E: Troubleshooting, continued

TV Channels		
	Symptom	Remarks
3.	Name options are not available for some channels.	You can name only memorized analog channels and memorized digital channels not named by the broadcaster.
4.	When ChannelView list is displayed, information appears incomplete	<ul style="list-style-type: none"> Available information is sent from the broadcaster or cable provider. No other data is available. Make sure the TV clock is set correctly.

TV Power On/Off		
	Symptom	Remarks
1.	TV takes an excessively long time to power on.	<ul style="list-style-type: none"> When switched on, the TV needs time to boot up, just as a computer does. Also, the TV's lamp requires a few moments to heat up to full brightness. TV Energy Mode is set to Low Power. Change TV Energy Mode to Fast Power On in the Setup menu.
2.	You cannot program the TV to turn on automatically (Timer function)	<ul style="list-style-type: none"> The TV may be locked. The clock may not be set. TV Energy Mode is set to Low Power. Change to Fast Power On in Setup menu.
3.	The TV will not turn on after being plugged in.	If light on front panel is blinking, wait for at least one minute for the light to turn off, then press POWER again.
4.	TV turned itself off and the light on the front panel started to blink.	<ul style="list-style-type: none"> Momentary power fluctuation caused the TV to turn off to prevent damage. Wait for the green light to stop flashing and turn the TV on again. If the TV does not stay on, use the System Reset button on the front panel. If this happens frequently, obtain an AC line power conditioner/surge protector. An unusual digital signal may have been received, triggering a protection circuit. Wait for the light to stop flashing and turn TV on.
5.	TV turned itself off and the STATUS is a steady yellow.	<ul style="list-style-type: none"> The TV has overheated. Clear blocked air vents and ensure at least four inches of clearance on all sides of the TV. Clean the lamp-cartridge air filter. See Appendix B.
6.	TV will not power off.	Use the System Reset button.

Picture		
	Symptom	Remarks
1.	Picture does not look like a high-definition picture.	Not all signals are high-definition signals. To receive high-definition programming from your cable or satellite provider, you must subscribe to the provider's high-definition service. Some over-the-air broadcasts are in high-definition and can be received with a high-quality antenna suited to your location.
2.	Picture has become dimmer.	<ul style="list-style-type: none"> The lamp is nearing the end of its life. Order a new lamp. See Appendix B for ordering information and replacement instructions. Adjust picture brightness and contrast to maximum levels. Change Lamp Mode from Standard to Bright.
3.	There is a large black or gray rectangle on the screen.	The TV's analog closed captioning has been set to "text" mode in the Captions menu. Turn off because there is no text information being broadcast.

Appendix E: Troubleshooting, continued

Picture		
Symptom	Remarks	
4.	You cannot view a picture when playing a VHS tape.	Check your VCR's owner's guide for further troubleshooting.
5.	VCR or DVD player's on-screen menus jitter up and down.	Possible cause: Many VCRs and DVD players provide on-screen menus at only half-resolution. These lower-resolution graphics may appear to jitter up and down when the TV converts them to high-definition graphics.
6.	When viewing a stopped VCR, white lines are rolling on the screen.	<ul style="list-style-type: none"> • Turn off video mute for the VCR. • Begin playing the tape. • Change the VCR input to the antenna input.
7.	A color program appears as a black and white image, or the colors are dim, or the screen is black.	The PerfectColor color balance has been incorrectly set. Reset the PerfectColor balance.
8.	Picture from an HDMI input is noisy (poor quality).	Upgrade a Category 1 (unmarked) HDMI cable to a Category 2 HDMI cable.
9.	The image from a computer appears distorted when viewed on the TV.	Normal TV operation. The TV does not correct distortion in the picture from a computer because the correction process may cause the edges of the image to be cut off.

Sound <i>(see also NetCommand troubleshooting for A/V receiver setup)</i>		
Symptom	Remarks	
1.	There is no sound even when the volume is turned up.	<ul style="list-style-type: none"> • Check if the MUTE button is on. • The TV's "Listen to:" setting may be set to SAP. • Check that the Speakers option is set to TV to hear sound from the TV speakers. • If using an A/V receiver, check that the Speakers option is set to AV Receiver to hear sound from the A/V receiver speakers. • Perform a System Reset.
2.	The sound does not match the screen picture.	<ul style="list-style-type: none"> • The TV's Listen to: setting may be set to SAP. • If using stereo or A/V receiver speakers, check their input selection in the Inputs > AVR menu. • If using stereo or A/V receiver, check that DIGITAL AUDIO OUT and/or AVR AUDIO OUTPUT on TV's back panel is connected to the A/V receiver. • NetCommand is set up incorrectly for the A/V receiver.

Indicators		
Symptom	Remarks	
1.	LAMP indicator light is a constant red.	Turn the TV off for at least 2 minutes. Turn it back on. If light is still red, the lamp has failed. Replace it. See Appendix B for lamp replacement information. For questions, please call Mitsubishi Consumer relations at (800) 332-2119.
2.	LAMP indicator light is a flashing yellow.	Lamp cover door is open or lamp cartridge is not secure. See Appendix B for lamp replacement information.
3.	STATUS indicator light is a steady yellow.	<ul style="list-style-type: none"> • Room temperature has exceeded proper levels. Cool the room. • The TV has overheated. Clear blocked air vents and ensure at least four inches of clearance on all sides of the TV. • Clean the air filter on the lamp cartridge. See Appendix B.

Appendix E: Troubleshooting, continued

Indicators	
Symptom	Remarks
4. STATUS indicator light is a steady/flashing red.	<ul style="list-style-type: none"> Unplug set from AC power. Plug back in and wait one minute for blinking to stop. Press SYSTEM RESET button and wait for blinking to stop. If blinking continues, service is required. Contact your dealer or a Mitsubishi Authorized Service Center to arrange for a service evaluation. Listings of Mitsubishi Authorized Service locations can be obtained from our web site, www.mitsubishi-tv.com or by calling 1-800-332-2119.

NetCommand	
Symptom	Remarks
1. Cannot see the menu from the A/V Receiver.	The A/V Receiver is not connected to any video input of the TV. To check the A/V Receiver menu, temporarily plug into an unused input of the TV, such as Input 3. Exit the Auto Input Sensing screen and select Input 3 from the Input Selection menu. Press MENU.
2. NetCommand unable to learn specific device keys.	<ul style="list-style-type: none"> Device does not use IR format for remote control signal. ITT and RF formats cannot be learned. Room lighting may affect the signal. Have the remotes very close (6 inches or less) to the TV during Learning. If learning a Mitsubishi remote control, make sure slide switch is not set to TV position. Some, but not all, device key functions can be learned by NetCommand. For example, POWER and PLAY may be learned, but other functions may not. The signal from the remote control may not be strong enough. Insert fresh batteries and try Learning again.
3. The A/V Receiver is the selected audio source but there is no sound.	<ul style="list-style-type: none"> Check to see if the A/V Receiver power is turned on. With the power turned on, redisplay the Input Selection menu and press ENTER to allow NetCommand to correctly select the A/V Receiver input. Incorrect setup in the Inputs > AVR menu. Check the device connection assigned in the AVR menu.
4. There is no sound when I switch to the A/V receiver using the Speaker setting in the AV menu, even though I have physically connected the TV to the A/V receiver and learned IR codes for the receiver inputs.	Wrong input or no input was assigned in the AV Receiver Learn screen. All audio should go to the A/V receiver as audio output from the TV unless the device's audio is connected directly to the A/V receiver. See chapter 6, "NetCommand," and perform the procedure to select the correct A/V receiver input.
5. There is no sound from the A/V receiver for my DVD player or other surround sound device even though I learned the IR code for the A/V receiver's DVD input or other input.	NetCommand A/V receiver setup for the DVD player or digital surround sound device or other device is not switching properly. See chapter 6, "NetCommand," and perform A/V receiver setup for a digital surround sound device.
6. I've selected my DVD player or other surround sound device in combination with the TV speakers but hear no sound from the TV speakers.	<p>If you have only an audio connection from the device to the A/V receiver, a physical audio connection from the device to the TV is also required.</p> <ul style="list-style-type: none"> Connect the left and right audio output from the device to the appropriate TV audio input. Now you can hear audio from the device through either the TV speakers or the A/V receiver. To switch audio sources, press AUDIO, press ▲ ▼ to show the Speakers option, then press ► to select AV Receiver or TV.
7. I "learned" the RECORD key for my VCR/DVR but when I pressed the RECORD key, the VCR/DVR did not record anything.	Check that the VCR or DVR is receiving a signal directly from your cable box or satellite receiver.

IEEE 1394 Recording		
Symptom		Remarks
1.	Program to be recorded was correctly selected from ChannelView, but incorrect program was recorded.	<ul style="list-style-type: none"> The broadcaster supplied program information that was incorrect and/or was changed after a recording was added to the Record List. TV Clock not set. Daylight Savings Time option is incorrect.
2.	Incomplete ChannelView program recorded.	Recording device may lack sufficient blank space to make a full recording.
3.	ChannelView program recording failed.	<ul style="list-style-type: none"> Connection and compatibility issues with IEEE 1394 (FireWire®) digital devices. This may include too many Firewire devices in use at one time, or the recording device not understanding the record command. Television lost power long enough to lose current clock time. TV energy Mode was set to Low Power. Change TV Energy mode to Fast Power On.
4.	Cannot record to or from the IEEE 1394 device, including dubbed recordings.	<ul style="list-style-type: none"> To initiate a recording to IEEE 1394 device, first switch the TV to the desired input (recordable inputs are ANT1, ANT2, INPUT 1–3). Press the  (RECORD) key. The Record > Schedule menu will display to allow setup of the recording. The source device for the recording is not powered on. When dubbing, the destination device for the recording is not powered on. The program is copy protected. The program has already been recorded once and the copy protection only allows one recording. Unapproved source device for copy protected material. The recording device cannot decode the copyright signal included in the signal source (try another device if available). The playing device (for dubbing) does not support copy-righted material. Source for recording is copyrighted Too many IEEE 1394 devices in network. Insufficient bandwidth available. Disconnect unused devices. IEEE 1394 source device has higher communication speed (S 400) than record device. If possible, reverse devices, play in the slower device and record in the faster device.

IEEE 1394 Devices		
Symptom		Remarks
1.	Excessive digital artifacts appear when viewing an IEEE 1394 device.	<ul style="list-style-type: none"> The IEEE 1394 cable is too long; 15 feet between devices is the maximum. There may be a slow device in the middle of the IEEE 1394 network. Move the slow devices to the end so that connections for faster devices do not pass through them.
2.	D-VHS recordings for digital cable have drop-outs (loss of picture or sound), or no playback.	Digital cable signals on IEEE 1394 can exceed the data rate standards supported by DVCR.
3.	The IEEE 1394 Device is no longer listed in the Input Selection menu.	<ul style="list-style-type: none"> The IEEE 1394 plug is disconnected or loose. The IEEE 1394 device has not been powered on. Turn on. The device has not been discovered. The device is not an audio/video device
4.	MENU button does not display a menu.	<ul style="list-style-type: none"> The IEEE 1394 device does not provide a menu. The TV cannot support the IEEE 1394 menus from this device.

IEEE 1394 Devices		
	Symptom	Remarks
5.	There is no audio and video from the IEEE 1394 device.	<ul style="list-style-type: none"> • The device is not turned on. Turn the device power on. • No tape is inserted in the DVCR. • The media is blank (has no recording). • The play command failed. Try pressing PLAY again on the device's remote control or front panel. • The device is already in use (for example, the device is currently recording). • The source is copy-protected or violates copy protection. • The device's digital video signal is not supported by the TV, as may be the case with an IEEE 1394 signal from a computer. Use analog connections instead, if available. • The device is not an audio/video device. • Too many other devices are already communicating over IEEE 1394. Remove or stop some devices and try again.
6.	The IEEE 1394 device cannot be selected (is grayed out).	<ul style="list-style-type: none"> • The device may be busy with a recording. Cancel the recording. • You have connected more than seven IEEE 1394 devices. Unplug the eighth device and one other device. Plug the new device back in.
7.	All IEEE 1394 devices disappear.	<ul style="list-style-type: none"> • The connected devices must not be in a loop that returns to the TV. Make sure a device is connected at the end. • Disconnect all the cables and devices from the TV. Replace them one by one to locate the problem device or cable. • Use System Reset (front control panel).
8.	An IEEE 1394 device has been plugged in but does not appear in the Input Selection menu (not discovered).	<ul style="list-style-type: none"> • The IEEE 1394 connection to the TV or another device is not secure or is loose. • The IEEE 1394 device is not powered on. • A device in the IEEE 1394 chain is not powered on. Turn on all the devices. • The device discovery can take as long as a minute to initiate. • IEEE 1394 cable is too long (maximum of 15 feet between devices). • The IEEE 1394 device uses an incompatible protocol and will not be discovered
9.	An IEEE 1394 device is not responding properly.	<ul style="list-style-type: none"> • Unplug the device's power cord. Wait at least ten seconds and plug it in again. • Some IEEE 1394 devices are not supported by the TV because of incompatible standards.

Trademark and License Information

LICENSOR'S SUPPLIERS DO NOT MAKE OR PASS ON TO END USER OR ANY OTHER THIRD PARTY, ANY EXPRESS, IMPLIED OR STATUTORY WARRANTY OR REPRESENTATION ON BEHALF OF SUCH SUPPLIERS, INCLUDING, BUT NOT LIMITED TO THE IMPLIED WARRANTIES OF NON-INFRINGEMENT, TITLE, MERCHANTABILITY OR FITNESS FOR A PARTICULAR PURPOSE.

Digital Light Processing® and DLP® are registered trademarks of Texas Instruments.

Manufactured under license from Dolby Laboratories. Dolby is a trademark of Dolby Laboratories.

Firewire® is a trademark of Apple Computer, Inc. registered in the U.S. and other countries.

HDMI™ the HDMI logo and High-Definition Multimedia Interface are trademarks or registered trademarks of HDMI Licensing LLC.

This product incorporates copyright protection technology that is protected by U.S. patents and other intellectual property rights. Use of this copyright protection technology must be authorized by Macrovision, and is intended for home and other limited pay-per-view uses only unless otherwise authorized by Macrovision. Reverse engineering or disassembly prohibited.

This product includes technology owned by Microsoft Corporation and cannot be used or distributed without a license from Microsoft Licensing, Inc.

The  logo and the words "Simplay™" and "Simplay HD™" are the trademarks of Silicon Image, Inc.

In the United States, TV Guide and other related marks are registered marks of Gemstar-TV Guide International, Inc. and/or one of its affiliates.

The TV Guide On Screen® system is manufactured under license from Gemstar-TV Guide International, Inc. and/or one of its affiliates.

The TV Guide On Screen system is protected by one or more of the following United States patents 4,908,713; 6,498,895; 6,850,693; 6,396,546; 5,940,073; 6,239,794 to Gemstar-TV Guide International, Inc. and/or its subsidiaries.

Gemstar-TV Guide International, Inc. and/or its related affiliates are not in any way liable for the accuracy or availability of the program schedule information or other data in the TV Guide On Screen system and cannot guarantee service availability in your area. In no event shall Gemstar-TV Guide International, Inc. and/or its related affiliates be liable for any damages in connection with the accuracy or availability of the program schedule information or other data in the TV Guide On Screen system.

x.v.Color and the **x.v.Color** logo are trademarks of Sony Corporation.

ChannelView™, DeepField™ Imager, Easy Connect™, NetCommand®, PerfectColor™, PerfectTint™, Plush 1080p®, QuickView™, SharpEdge™, Smooth120Hz™ are trademarks of Mitsubishi Digital Electronics America, Inc.

Mitsubishi TV Software

END-USER LICENSE AGREEMENT FOR EMBEDDED SOFTWARE

IMPORTANT – READ CAREFULLY: This License Agreement is a legal agreement between you (either an individual or an entity) and Mitsubishi Digital Electronics America, Inc. (MDEA) for all software pre installed and/or provided along with this television (“Software”). By utilizing this television and Software, you agree to be bound by the terms of this License Agreement.

The Software is protected by United States copyright laws and international treaty provisions, as well as other intellectual property laws and treaties. The Software is licensed, not sold.

1. **LICENSE GRANT.** MDEA grants you a non-exclusive, non-transferable, limited right and license to use one copy of the Software only with the Mitsubishi television model that included this owner’s guide and owned by you.

2. **RIGHTS AND LIMITATIONS.**

Software Not for Resale. You may not resell or otherwise transfer for value the Software, except in conjunction with a sale of the TV that Software has been pre installed.

Prohibition on Reverse Engineering, Decompilation and Disassembly. The Software contains trade secrets or other proprietary material in its human perceivable form and to protect them, you may not reverse engineer, decompile, or disassemble, or otherwise reduce the Software to any human perceivable form, except to the extent that the foregoing restriction is expressly prohibited by applicable law.

Separation of Components. The Software is licensed as a single product. Its component parts may not be separated for use on more than one TV.

No Rental. You may not rent, lease, lend, or sublicense the Software.

Trademarks. This License Agreement does not grant you any rights to any trademarks of MDEA.

3. **VIOLATIONS.** You understand that any use, copying or transfer of the Software, except as permitted pursuant to this License, may subject you to serious criminal and civil penalties including damages and an award to MDEA of attorneys’ fees in connection with any violation of this License. You further understand that you may be held legally responsible for any copyright infringement or other violation of intellectual property rights that is caused, encouraged, or induced by your failure to abide by the terms of the License. This license is effective until terminated, and will terminate immediately without notice from MDEA or judicial resolution if you fail to comply with any provision of this License.

4. **COPYRIGHT.** All title and intellectual property rights in and to the Software (including but not limited to any images, photographs, animations, video, audio, music, text, and “applets” incorporated into the Software), and any accompanying printed materials are owned by or licensed to MDEA. All title and intellectual property rights in and to the content which may be accessed through use of the Software is the property of the respective content owner and may be protected by applicable copyright or other intellectual property laws and treaties. This License Agreement grants you no rights to use such content, except that you own the media on which the Software is recorded, but MDEA and its licensors retain ownership of the Software itself. All rights not expressly granted are reserved by MDEA.

5. **EXPORT RESTRICTIONS.** MDEA is licensing the Software for use within the United States. You agree that you will not export or re-export the Software. You specifically agree not to export or re-export the Software: (i) to any country to which the U.S. has embargoed or restricted the export of goods or services, which currently include, but are not necessarily limited to Cuba, Iran, Iraq, Libya, North Korea, Sudan, and Syria, or to any national of any such country, wherever located, who intends to transmit or transport the Software back to such country; (ii) to any person or entity who you know or have reason to know will utilize the Software in the design, development, or production of nuclear, chemical, or biological weapons; or (iii) to any person or entity who has been prohibited from participating in U.S. export transactions by any federal agency of the U.S. government. You warrant and represent that neither the BXA nor any other U.S. federal agency has suspended, revoked, or denied your export privileges.

6. **DISCLAIMER OF WARRANTY. EXCEPT AS OTHERWISE PROVIDED IN THIS LICENSE OR IN THE LIMITED WARRANTY APPLICABLE TO THE TV, MDEA MAKES NO OTHER WARRANTIES OF ANY KIND WHATSOEVER REGARDING THE SOFTWARE AND HEREBY EXPRESSLY DISCLAIMS ALL WARRANTIES OF ANY KIND WHATSOEVER, EXPRESS OR IMPLIED, WITH RESPECT TO THE SOFTWARE. ALL IMPLIED WARRANTIES, INCLUDING, WITHOUT LIMITATION, THE IMPLIED WARRANTIES OF MERCHANTABILITY AND FITNESS FOR A PARTICULAR PURPOSE ARE HEREBY EXPRESSLY DISCLAIMED BY MDEA. IN NO EVENT SHALL MDEA BE LIABLE TO YOU OR ANY THIRD PARTIES, IN CONTRACT, IN TORT OR OTHERWISE, FOR ANY DIRECT, INDIRECT, SPECIAL, INCIDENTAL OR CONSEQUENTIAL DAMAGES OF ANY KIND OR NATURE. BECAUSE SOME JURISDICTIONS DO NOT ALLOW THE EXCLUSION OR LIMITATION OF IMPLIED WARRANTIES, THE ABOVE LIMITATION MAY NOT APPLY TO YOU.**

7. **LIMITATION OF LIABILITY. MDEA SHALL NOT, UNDER ANY CIRCUMSTANCES BE LIABLE TO YOU OR ANY THIRD PARTIES FOR ANY DAMAGES OF ANY NATURE, WHETHER INDIRECT, SPECIAL, INCIDENTAL, CONSEQUENTIAL OR OTHERWISE, INCLUDING, BUT NOT LIMITED TO, ANY CLAIMS FOR LOST PROFITS, LOSS OF GOOD WILL OR EXPENDITURES MADE OR COMMITTED FOR IN RELIANCE ON THE CONTINUATION OF THIS LICENSE. YOU AGREE THAT NEITHER MDEA’S BREACH OF THIS LICENSE NOR ITS FAILURE TO REPAIR A DEFECT, ERROR OR BUG SHALL CONSTITUTE A FAILURE OF THE ESSENTIAL PURPOSE OF THIS LICENSE. BECAUSE SOME JURISDICTIONS DO NOT ALLOW THE EXCLUSION OR LIMITATION OF LIABILITY FOR CONSEQUENTIAL OR INCIDENTAL DAMAGES, THE ABOVE LIMITATIONS MAY NOT APPLY TO YOU. MDEA’s liability to you for direct damages for any cause whatsoever and regardless of the form of the action, will be limited to the money paid by you for the TV (based on fair market value of the TV) that caused the damages.**

8. **GENERAL.** This License Agreement will be governed by the laws of the State of California.

WARNING: This product contains chemicals known to the State of California to cause cancer and/or birth defects or other reproductive harm.

Mitsubishi DLP Projection Television Limited Warranty

MITSUBISHI DIGITAL ELECTRONICS AMERICA, INC. ("MDEA") warrants as follows to the original purchaser of this television from an authorized MITSUBISHI Audio/Video Dealer, should it prove defective by reason of against defects arising from improper workmanship and/or material:

a. Parts. The lenticular (i.e. front picture) screen is warranted against defects in materials and workmanship for a period of thirty (30) days from the date of the original purchase at retail. The lamp and all other parts (except any software incorporated into this television) are warranted for a period of one (1) year from the date of the original purchase at retail. We will repair or replace, at our option, any defective part without charge for the part. Parts used for replacement may be replaced with those of like kind and quality and may be new or remanufactured. Parts used for replacement are warranted for the remainder of the original warranty period.

b. Embedded Software. MDEA warrants that all software incorporated into this television set (the "Embedded Software") will perform in accordance with the functional description of Embedded Software in all material respects, but MDEA does not warrant that the Embedded Software is error-free. MDEA also does not warrant that the Embedded Software will be compatible under IEEE 1394 AV/C and HAVi software standards with products produced by any other manufacturer. The limited warranty contained in this section shall continue for a period of one (1) year from the date of the original purchase at retail. If, after prompt notice within the warranty period, MDEA determines that the Embedded Software has failed to perform in accordance with such functional description in all material respects and if such failure is not due to accident, misuse, modification or misapplication of the Embedded Software, then MDEA shall modify or replace the nonconforming Embedded Software at no charge to you, which at MDEA's sole discretion may be fulfilled by means of modification or replacement software contained on a replacement memory card for Customer installation. The foregoing shall be MDEA's sole obligation to you under this limited warranty. All rights under this limited warranty on the Embedded Software also subject to your acceptance of and compliance with the terms of the Software License Agreement applicable to this television, and this limited warranty on the Embedded Software shall be null and void if the Embedded Software is modified or changed in any manner except as specifically authorized by MDEA.

c. Labor. For thirty (30) days after the original purchase at retail, we will repair or replace, at our option, the lenticular screen if it proves defective. For certain items that are designed to be replaced by the consumer, including (but not limited to) some Embedded Software, the consumer is solely responsible for any replacement labor. For all other parts, we will provide the labor for a warranty repair by an authorized MITSUBISHI service center without charge for one (1) year from the original date of purchase at retail.

d. Notice. To obtain warranty service, you must notify an authorized MITSUBISHI service center of any defect within the applicable warranty time period.

e. This DLP Projection Television uses a single DLP chip to create the screen image. This technology creates the image using small dots, or picture elements (pixels). Your DLP Projection TV is manufactured to a high level of performance and quality, in fact, 99.99% perfect in the number of properly functioning pixels. As in other display technology, sometimes a pixel is continuously active, inactive or the incorrect color. Our standard is clear; MDEA warrants only that the percentage of properly functioning pixels will be not less than 99.99% of all pixels.

BEFORE REQUESTING SERVICE, please review the instruction booklet to insure proper installation and correct customer control adjustment. If the problem persists please arrange for warranty service.

1. TO OBTAIN WARRANTY SERVICE:

a. Contact your nearest authorized MITSUBISHI service center, whose name and address can be obtained from your MITSUBISHI dealer, by writing at the address provided below, calling MDEA at the 800-332-2119, or by using the support feature of our website at www.Mitsubishi-tv.com.

b. Warranty service will be provided in your home or, if required, at an authorized service shop, provided that your television is located within the geographic territory customarily covered by an authorized MITSUBISHI service center. If not, you must either deliver your television to an authorized service location at your own expense, or pay for any travel and/or transportation costs the service center may charge to and from your home. Actual service labor will be provided without charge.

c. Proof of purchase date from an authorized MITSUBISHI dealer is required when requesting warranty service. Present your sales receipt or other document which establishes proof and date of purchase. THE RETURN OF THE OWNER REGISTRATION CARD IS NOT A CONDITION OF COVERAGE UNDER THIS LIMITED WARRANTY. However, please return the Owner Registration Card so that we can contact you should a question of safety arise which could affect you.

d. To obtain a replacement lamp, order the lamp directly from the MDEA Parts Department at (800) 553-7278.

2. THIS LIMITED WARRANTY DOES NOT COVER:

a. Up to .01% pixel outages (small dot picture elements that are dark or incorrectly illuminated).

b. Damage to the lenticular screen or Fresnel lens, screen frame, cosmetic damage or to any other damage where such damage is caused by unauthorized modification, alteration, repairs to or service of the product by anyone other than an authorized MITSUBISHI service center; physical abuse to or misuse of the product (including any failure to carry out any maintenance as described in the Owner's Guide including air vent cleaning or any product damaged by excessive physical or electrical stress); any products that have had a serial number or any part thereof altered, defaced or removed; product use in any manner contrary to the Owner's Guide; freight damage; or any damage caused by acts of God or other factors beyond the reasonable control of MDEA, such as power surge damage caused by electrical system or lightning. This limited warranty also excludes service calls where no defect in the product covered under this warranty is found, service calls related to unsatisfactory audio or visual reception or signal unless caused by a defect in the product that is covered under this limited warranty, all costs, expenses or any other damages arising from product installation, or set-ups, any adjustments of user controls (including contrast, brightness, color, tint, fine tuning, sharpness), other adjustment necessary to prepare the unit for display or use, connection with any external audio receiver, antenna, cable or satellite systems, or service of products purchased or serviced outside the U.S.A. Please consult the operating instructions contained in the Owner's Guide furnished with the product for information regarding user controls.

3. ANY EXPRESS WARRANTY NOT PROVIDED HEREIN, AND ANY REMEDY WHICH, BUT FOR THIS PROVISION, MIGHT ARISE BY IMPLICATION OR OPERATION OF LAW, IS HEREBY EXCLUDED AND DISCLAIMED. THE IMPLIED WARRANTIES OF MERCHANTABILITY AND OF FITNESS FOR ANY PARTICULAR PURPOSE ARE EXPRESSLY LIMITED TO A TERM OF ONE YEAR.

4. UNDER NO CIRCUMSTANCES SHALL MDEA BE LIABLE TO PURCHASER OR ANY OTHER PERSON FOR ANY INCIDENTAL, SPECIAL OR CONSEQUENTIAL DAMAGES, WHETHER ARISING OUT OF BREACH OF WARRANTY, BREACH OF CONTRACT, OR OTHERWISE.

5. Some states do not allow limitations on how long an implied warranty lasts, or the exclusion or limitation of incidental, special, or consequential damages, so the above limitations or exclusions may not apply to you.

6. This limited warranty gives you specific legal rights, and you may also have other rights which vary from state to state.

7. In the event of any dispute under this limited warranty, jurisdiction and venue for resolving that dispute will be in the state where the television was purchased and the laws of such state will govern.



MITSUBISHI DIGITAL ELECTRONICS AMERICA, INC.

9351 Jeronimo Road
Irvine, CA 92618-1904

Index

- A**
- A/V Discs 67
- A/V Memory Reset 81
- A/V Receiver
 - Adding NetCommand Control 60, 61, 62
 - and the TV Speakers 42
 - and TV's Remote Control 60, 73
 - Audio Lock 74
 - Codes 75
 - Connecting 9, 10, 23, 61
 - Controlling Sound Volume 14
- A/V Reset 7, 81
- Adjust Keys (Up/Down/Left/Right) 28, 38
- Air Filter 70
- Anamorphic Picture Format 33, 63
 - Playback 63
- Antenna
 - Connecting 19
- Antenna Inputs (ANT 1/MAIN, ANT 2/AUX) 9
- Audio Lock 74
- Audio Menu 42
- Auto-off. *See* Sleep Timer (auto-off)
- Auto-on. *See* Timer
- Auto Input Sensing
 - Description 6
 - TV Setup 13
- B**
- Back Panel (described) 9, 10
- Batteries 12
- Bright (Lamp Mode) 48
- C**
- Cable Box
 - and TV's Remote Control 29, 73
 - Codes 76
 - Connecting 17, 18, 22, 23
 - IEEE 1394 25
- Camcorder
 - Connecting (Analog) 24
 - IEEE 1394 26
 - Power 25
- Captions Menu 43
- Channels. *See also* Fav
 - Changing 27
 - Channel Lock 45
 - Digital Channel Numbers 68
 - Memorizing 13
 - Naming 45
 - Physical/Virtual Channel Numbers 45
 - Scan (description) 44
 - Status Display 31
 - Troubleshooting 83
- ChannelView™ Channel Listings 30
 - and Recording 65
- Cleaning 4
- Clock, Set Date and Time 46
- Closed Captions 43
- Color Adjustments 39, 41
 - Reset Color 39, 81
- Component Inputs (Y Pb Pr) 10
- Computer
 - and Display Formats 16, 68
 - Connecting 15
- Copy Restrictions 67
 - and NetCommand 63
- Cropped Playback 63
- D**
- Date. *See* Clock
- Defaults, Resetting 81
- Digital Audio Out 9
- Display Format Definitions 33
- Dolby Digital 9, 23, 61, 68
 - and IEEE 1394 25
- DVD Player
 - and TV's Remote Control 29, 73
 - Codes 77
 - Connecting 20
- DVI Device, Connecting 20
- E**
- Energy Mode 48
- F**
- F1–F4 Keys 29, 56
- Fan Noise 4
- Fast Power On 48
- FAV (Favorite Channels) 32, 45
- FORMAT Key 33, 34
- Freeze Picture 29
- Front Panel Lock 53
- FX Gaming Menu Options 40
- G**
- Games
 - 3D GLASSES EMITTER Jack 10
 - Game as Input Name 49
 - Game Mode (FX Gaming Option) 40
 - Game Picture Mode 41
 - HDMI Cables for Games 10
- GUIDE Key 28, 73
 - ChannelView 30
 - TV Guide On Screen System 50
- H**
- HDMI
 - Changing Out an HDMI Device 14
 - Connecting an HDMI Device 18
 - Disconnecting and the Input Selection Menu 49
 - HDMI Cable Categories 10
 - HDMI Jack 10
 - NetCommand for HDMI Devices 7, 29, 73
- HDTV Cable Box or Satellite Receiver
 - with Component Video, Connecting 17
- HDV video 25
- HD (High-Definition) Signal) 33
- I**
- IEEE 1394 Devices
 - A/V Discs 67
 - Camcorders 26
 - Compatible IEEE 1394 Devices 25
 - Connecting IEEE 1394 Devices 9, 26
 - Recording 67
 - TV Connection Speed 26
- INFO Key
 - ChannelView 30
 - in TV Menus 38
 - USB Photo Menu 36
- Input Jacks (Standard Audio/Video) 9
- Input Selection Menu
 - Choose Viewing Source 27
 - Icon Order 49
 - INPUT Key 28
- IR (infrared) Emitter Placement 55
- J**
- JPEG Photo Files 36
- L**
- Lamp Cartridge Replacement 69
- LAMP Indicator. *See* LED Indicator Lights
- Lamp Mode 48
- Language
 - in Digital Programs 42
 - SAP (Second Audio Program) 42
- Language Menu 44
- Learn. *See* NetCommand
- LED Indicator Lights 8
 - Troubleshooting 85
- Lock Menu. *See* Lock TV
- Lock TV
 - Bypassing the Lock 71
 - Lock by Channel 45
 - Lock by Ratings 52
 - Lock by Time 53
 - Lock Front Panel 53
 - Preset V-Chip Blocking 51

Low Power (Energy Mode) 48

M

Media Setup Menu 37

Memorizing Channels 13

Add Single Channel to Memory
44, 45

Mute

MUTE key 28
Video Mute 40

N

NetCommand

A/V Receiver Control 60

Compared to Programming the
Remote Control 73

Description 54

Initial Setup for Most Devices 56

NetCommand for HDMI Devices
7, 29, 73

Operating 58, 59

Specialized Device Keys 57

Troubleshooting 86

Noise, Video 40

P

Parent Menu 52

Pass Code

Resetting 71

Setting 51

PAUSE Key 29

PerfectColor 39

PerfectTint 39

Personal Computer 66

Photo Viewing 37

Picture

AV Menu Controls 39, 40

Format Displays 34

Picture Quality and Film Mode
40

Troubleshooting 84, 85

Picture Mode 41

Power Consumption

Energy Mode 48

Specifications 68

Power On/Off 12, 27

Troubleshooting 84

Q

QV Key (QuickView™) 28

and FAV Key 32

R

Recording

Cancelling Recordings 64

NetCommand-Controlled Re-
cording 63

Recording and TV Energy Mode
48

Recording Formats 63

Record > Setup Menu 63

RECORD Key 87

RECORD Key and VCRs 65

Record List 64

RECORD OUTPUT Jacks 10

Split Screen 10

Remote Control

Keys and Functions 28, 29

Programming Codes (reference
chart) 75

Programming Instructions 74

Programming vs. NetCommand
“Learning” 73

Reset 29

Reset

A/V Reset (all settings) 7

AV Menu Reset (by input) 39

Color 81

DVCR Counter 66

Pass Code 71

Remote Control 29

Remote Control Audio Lock 74

System Reset 7

TV Reset Comparison Guide 81

S

S-Video 9

Connecting an S-Video Device
18

Safeguards 5

SAP (second audio program) 31, 42

Satellite Receiver

and the Remote Control 73

Connecting 17, 18

SD (Standard-Definition Signal) 33

Service and Support 82

Signal Definitions 33

Sleep Timer (auto-off) 27

Sound

Audio Settings 42

Controlling A/V Receiver Volume
14, 60

Simulated Stereo 42

Troubleshooting 85

Turn TV Speakers On/Off 42

Speakers Option

In Audio Menu 42

Specifications, TV 68

Split Screen

and Recording 10

Description 35

Standard-Definition Signal 33

Standard (Lamp Mode) 48

Stand Part Numbers 4

Status Display 31

STATUS Indicator. *See* LED Indicator
Lights

Stereo System. *See* A/V Receiver

Surround Sound 9, 10, 23, 62

Simulated 42

System Reset 7, 82

T

3D GLASSES EMITTER 10

Time. *See* Clock

Timer

Sleep Timer (auto-off) 27

TV Timer (auto-on) 47

Time Zone. *See* Clock

Troubleshooting 81

TV Guide On Screen

Access Requirements 4

and ChannelView 65

and GUIDE Key 28

and the Record List 64

Connection Requirements 21,
22, 50

Description 7

Recording 65

Setup 50

Setup Requirements 54

TV Guide On Screen and TV

Energy Mode 48

V

V-Chip Ratings

Applying Restrictions 51

Definitions 52

In Status Display 31

VCR

Connecting 9, 21, 22

IEEE 1394 25

Troubleshooting 85

Video from a Digital Camera 37

Video Game. *See* Games

Video Menu 41

Viewing Device. *See* Input Selection
Menu

W

Wall Outlet Cable 19

X

x.v.Color 10, 18, 41

Z

ZIP code 50



Website:
www.mitsubishi-tv.com

E-mail:
MDEAservice@mdea.com

**For questions, call Consumer Relations at
800-332-2119**

**To order replacement or additional
remote controls, lamp cartridges, or Owner's Guides**

Visit our website www.mitsuparts.com

or call

800-553-7278

SYSTEM RESET

If the TV does not respond to the remote control, front panel controls, or will not power on/off, press the **SYSTEM RESET** button on the front panel.

The green LED will flash quickly for about one minute. When the green LED stops flashing, you may turn on the TV. Settings changes you made most recently, before using **SYSTEM RESET**, may be lost.